



# permeable pavements



GUIDE TO THE DESIGN,  
CONSTRUCTION AND  
MAINTENANCE OF CONCRETE  
BLOCK PERMEABLE PAVEMENTS



**Interpave**

THE PRECAST CONCRETE PAVING  
AND KERB ASSOCIATION



[www.paving.org.uk](http://www.paving.org.uk)

# GUIDE TO THE DESIGN, CONSTRUCTION AND MAINTENANCE OF CONCRETE BLOCK PERMEABLE PAVEMENTS



THE PRECAST CONCRETE PAVING  
AND KERB ASSOCIATION

**Published by Interpave  
The Precast Concrete Paving & Kerb  
Association  
60 Charles Street,  
Leicester LE1 1FB**

**tel: 0116 253 6161  
fax: 0116 251 4568  
e-mail: [info@paving.org.uk](mailto:info@paving.org.uk)  
website: [www.paving.org.uk](http://www.paving.org.uk)**

**Interpave is a Product Association of the  
British Precast Concrete Federation Ltd.  
© 2008 BPCF Ltd.**

**Every effort has been made to ensure that the statements made  
and the opinions expressed in this publication provide a safe  
and accurate guide; however, no liability or responsibility of any  
kind (including liability for negligence) can be accepted in this  
respect by the publishers or the authors.**

# CONTENTS

<b>1. INTRODUCTION</b>	<b>p3</b>
<b>2. LEGISLATION AND GUIDANCE</b>	<b>p4</b>
<b>3. PERMEABLE PAVEMENT PRINCIPLES</b>	<b>p5</b>
<b>3.1 THE CONCEPT</b>	<b>p5</b>
<b>3.2 SURFACE WATER RUNOFF</b>	<b>p6</b>
3.2.1 WATER FLOW	p6
3.2.2 POLLUTION	p8
3.2.3 CLIMATE CHANGE	p8
<b>3.3 BENEFITS</b>	<b>p9</b>
3.3.1 WATER FLOW	p11
3.3.2 WATER QUALITY IMPROVEMENT	
<b>4. PROPERTIES</b>	<b>p12</b>
<b>4.1 TYPES OF CONCRETE BLOCK</b>	<b>p12</b>
<b>4.2 TYPES OF PERMEABLE PAVEMENT</b>	<b>p12</b>
4.2.1 SYSTEM A – TOTAL INFILTRATION	p13
4.2.2 SYSTEM B – PARTIAL INFILTRATION	p13
4.2.3 SYSTEM C – NO INFILTRATION	p14
<b>4.3 PERMEABLE SUB-BASE REPLACEMENT SYSTEMS</b>	<b>p15</b>
<b>4.4 RAINWATER HARVESTING</b>	<b>p15</b>
<b>4.5 RETROFITTING</b>	<b>p17</b>
<b>5. SELECTION OF A PAVEMENT SYSTEM</b>	<b>p18</b>
<b>5.1 SUBGRADE PERMEABILITY</b>	<b>p18</b>
<b>5.2 SITE CHARACTERISTICS</b>	<b>p18</b>
5.2.1 GROUND WATER TABLE LEVEL	p19
5.2.2 POLLUTION PREVENTION	p19
5.2.3 DISCHARGE CONSENTS	p20
5.2.4 PROXIMITY TO BUILDINGS	p20
5.2.5 OTHER CRITERIA	p20
<b>5.4 SERVICE CORRIDORS</b>	<b>p22</b>
<b>6. STRUCTURAL AND HYDRAULIC DESIGN</b>	<b>p23</b>
<b>6.1 DESIGN CRITERIA</b>	<b>p23</b>
<b>6.2 WATER STORAGE DESIGN</b>	<b>p24</b>
6.2.1 CLIMATE CHANGE	p25
6.2.2 UNITS	p25
6.2.3 INFILTRATION PAVEMENTS (SYSTEM A)	p26
6.2.4 SOURCE CONTROL	p26
6.2.5 INTERCEPTION STORAGE	p26
6.2.6 ATTENUATION STORAGE	p27
6.2.7 IMPACT OF SLOPE ON AVAILABLE STORAGE	p31
6.2.8 DRAINING IMPERMEABLE AREAS ONTO PERMEABLE AREAS	p32
6.2.9 LONG TERM STORAGE	p33
6.2.10 USE OF DRAINAGE ANALYSIS AND DESIGN SOFTWARE	p34
6.2.11 CONVEYANCE OF WATER TO OUTFALL	p34
6.2.12 STORAGE DESIGN EXAMPLE	p35
<b>6.3 STRUCTURAL DESIGN</b>	<b>p35</b>
6.3.1 THE STRUCTURAL DESIGN PROCESS	p36
6.3.2 STAGE 1 – SELECTION OF LOADING CATEGORY	p37
6.3.3 STAGE 2 – SELECTION OF PAVEMENT COURSE MATERIALS AND THICKNESSES	p38
6.3.4 STAGE 3 – ADJUSTMENT TO PAVEMENT DESIGN FOR LOW CBR SUBGRADES	p40
6.3.5 STAGE 4 – PROTECTION FROM CONSTRUCTION TRAFFIC	p41
6.3.6 DENSE BITUMEN MACADAM	p41

<b>7. SPECIFICATION AND MATERIALS</b>	<b>p43</b>
<b>7.1 PAVING BLOCKS</b>	<b>p43</b>
<b>7.2 LAYING COURSE AND JOINTING MATERIAL</b>	<b>p43</b>
7.2.1 LAYING COURSE AND SUB-BASE GRADING COMPACTIBILITY	p43
7.2.2 JOINTING AND VOIDS MATERIAL	p44
<b>7.3 COARSE GRADED AGGREGATE</b>	<b>p45</b>
<b>7.4 HYDRAULICALLY BOUND COARSE GRADED AGGREGATE</b>	<b>p47</b>
<b>7.5 DESIGN BITUMEN MACADAM (DBM)</b>	<b>p47</b>
<b>7.6 CAPPING</b>	<b>p47</b>
<b>7.7 IMPERMEABLE MEMBRANE</b>	<b>p47</b>
<b>7.8 GEOTEXTILES</b>	<b>p47</b>
7.8.1 CHARACTERISTICS	p48
7.8.2 QUALITY	p48
7.8.3 INSTALLATION PROCEDURE	p48
<b>8. DETAILING</b>	<b>p50</b>
<b>8.1 EDGE RESTRAINTS</b>	<b>p50</b>
<b>8.2 OUTLETS AND CONVEYANCE</b>	<b>p50</b>
8.2.1 SPACING OF OUTFLOW PIPES	p52
<b>8.3 INLETS FROM ROOF DRAINAGE</b>	<b>p53</b>
<b>8.4 SLOPING SITES</b>	<b>p54</b>
<b>8.5 LANDSCAPING</b>	<b>p55</b>
<b>8.6 SERVICE CORRIDORS</b>	<b>p55</b>
<b>9. CONSTRUCTION</b>	<b>p56</b>
<b>9.1 SITE PRECAUTIONS</b>	<b>p56</b>
<b>9.2 CONCRETE BLOCK PAVING</b>	<b>p56</b>
<b>9.3 JOINT SEALING</b>	<b>p57</b>
<b>9.4 LAYING COURSE AND JOINT FILLING</b>	<b>p57</b>
<b>9.5 PROTECTION FROM CONSTRUCTION TRAFFIC</b>	<b>p57</b>
<b>9.6 GEOTEXTILE</b>	<b>p58</b>
<b>9.7 PERMEABLE SUB-BASE</b>	<b>p58</b>
<b>9.8 IMPERMEABLE MEMBRANE</b>	<b>p59</b>
<b>9.9 PREPARATION OF SUBGRADE</b>	<b>p59</b>
<b>10. PERFORMANCE AND MAINTENANCE</b>	<b>p60</b>
<b>10.1 PERFORMANCE CHARACTERISTICS</b>	<b>p60</b>
10.1.1 SURFACE INFILTRATION RATES AND CLOGGING	p60
10.1.2 FREEZING	p61
10.1.3 HEALTH & SAFETY AND ACCESSIBILITY	p62
<b>10.2 MAINTENANCE</b>	<b>p62</b>
<b>10.3 ADOPTION</b>	<b>p63</b>
<b>11. REFERENCES AND OTHER SOURCES OF INFORMATION</b>	<b>p64</b>
<b>11.1 REFERENCES</b>	<b>p64</b>
<b>11.2 OTHER SOURCES OF INFORMATION</b>	<b>p67</b>
<b>APPENDIX 1</b>	<b>p68</b>
<b>DESIGN EXAMPLES</b>	<b>p68</b>
<b>SITE ASSESSMENT</b>	<b>p68</b>
<b>WATER STORAGE DESIGN</b>	<b>p69</b>
<b>ATTENUATION SYSTEM C</b>	<b>p69</b>
<b>CONVEYANCE SIZING</b>	<b>p71</b>
CALCULATION OF PERMEABLE SUB-BASE FLOW CAPACITY BELOW THE PERMEABLE AREA	p73
CALCULATE FLOW THROUGH THE PERMEABLE SUB-BASE USING DARCY'S LAW	p73
CALCULATION OF PERMEABLE SUB-BASE FLOW CAPACITY ALONG THE YELLOW AREA	p74
<b>STRUCTURAL DESIGN SYSTEMS A &amp; C</b>	<b>p75</b>
<b>FINAL PAVEMENT THICKNESS</b>	<b>p77</b>

## 1. INTRODUCTION

This Guide is aimed at planners, designers, engineers and other decision makers to assist them in the design, construction and maintenance of concrete block permeable pavements. This sustainable drainage technology is growing rapidly in popularity in a number of countries: for example, some 500,000m<sup>2</sup> of concrete block permeable pavements have been installed just on retail developments alone over the last seven years in Ireland. It gives guidance based on research undertaken at Newcastle University, information from Germany – where over 20,000,000m<sup>2</sup> of permeable pavements are installed annually, and published data from the USA – where the ‘Interlocking Concrete Pavement Institute’ has pioneered the development of permeable paving guidance.

It follows the recommendations of various authoritative publications, a full list of which is given in the Reference Section, but in particular ‘*The SUDS Manual*’ (CIRIA, 2007) which is the most authoritative and up to date guidance on Sustainable Drainage Systems (SUDS) in the UK. Readers should be aware that more recent experience gained from an expanding use of permeable pavements has rendered some guidance outdated in older publications from various sources, and they should be treated with caution. The Guide also recognises European and British Standards and encourages the use of pavement construction materials which are widely available. It also aims to encourage the development of innovative products and materials, which should not only help meet the objectives of SUDS and the requirements of the European Water Framework Directive but also anticipate future changes. Although this Guide offers the latest, definitive design method for concrete block permeable pavements, other methods exist which have proved successful over the years. Finally, **It is important to recognise that members of Interpave manufacture specific systems that may involve alternative approaches or specifications to those given in this guide.**

Although concrete block permeable pavement technology is growing in popularity and now well established alongside other SUDS techniques, user experience on real projects continues to add to the well of information, influencing future developments. Through regularly published, updated editions, this Guide aims to provide the latest, definitive guidance on permeable pavements. Interpave has also published ‘*Understanding Permeable Paving – guidance for designers, developers, planners and local authorities*’, covering background information, legal framework, adoption and case studies, available on **[www.interpave.org.uk](http://www.interpave.org.uk)**. Further guidance on other aspects of block paving – also relevant to concrete block permeable pavements – such as mechanical installation, cutting and reinstatement can also be found on the Interpave website.

**The main changes in this edition over Edition 5 relate to new legislation, not design and construction guidance.**

## 2. LEGISLATION AND GUIDANCE

Planning Policy Statement PPS 25 (Communities and Local Government, 2006) sets out Government policy in England on development and flood risk. In Scotland planning policy *SPP7* (Scottish Executive 2004) provides similar guidance, as does *TAN15* in Wales (Welsh Assembly Government 2004). The main aim is to ensure that flood risk is taken into account at all stages of the planning process to avoid placing developments in areas of flood risk or exacerbating flood risk elsewhere as a result of development. PPS 25 identifies that SUDS can deliver improved surface water management and requires that planning authorities should promote SUDS at every level to attenuate runoff and improve water quality and amenity. It states that both the **rates and volumes** of runoff from new developments should be “*No greater than the rates prior to the proposed development, unless specific off-site arrangements are made which result in the same net effect*”. It requires local authorities to reduce flood risk via the planning process in a manner that takes climate change into account and also enhances the environment. It recognises that SUDS can be used on any site.

In Scotland Planning Advice Note PAN 61 (Scottish Executive, 2001) gives good practice advice for planners and developers regarding the use of SUDS in developments.

The ‘*SUDS Manual*’ (CIRIA, 2007) provides best practice guidance on all aspects of the design, construction, operation and maintenance of SUDS. In particular it places emphasis on the use of source control techniques and requires SUDS designers to consider pollution removal and amenity aspects as well as a more comprehensive assessment of attenuation than has been required previously (to meet the same requirements as stated in PPS 25). Concrete block permeable pavements are ideal to help meet these new design criteria.

Of major importance, the *Flood and Water Management Act 2010* applies to any construction work that creates a building or other structure, including ‘anything that covers land’, that will affect the ability of land to absorb rainwater. Current arrangements for approval, construction and maintenance of conventional piped drainage will be replaced with similar procedures for SUDS. A new role for local (unitary and county) authorities as ‘SUDS Approving Bodies’ will be established and they will be required to adopt all SUDS schemes except single properties. National Standards for construction and maintenance of SUDS systems will also be developed by 2011.

In Scotland, a steering group – formed from the Sustainable Urban Drainage Scottish Working Party and The Society of Chief Officers for Transportation in Scotland (the umbrella body representing all local authorities in Scotland) – has instigated comprehensive guidance on SUDS for adoption. A draft version of *SUDS for Roads* was launched in September 2009.

The design of drainage systems, including attenuation and cleansing of surface water is included in current Building Regulations and Building Standards for England and Wales, and Scotland respectively.

**Further information on the Act, planning guidance and Building Regulations can be found in Interpave’s ‘Understanding Permeable Paving’ available from [www.paving.org.uk](http://www.paving.org.uk).**



### 3. PERMEABLE PAVEMENT PRINCIPLES

#### 3.1 THE CONCEPT

Concrete block permeable pavements are a mainstream type of pavement surface suitable for trafficking that also act as the drainage system. In conventional pavements rainwater is allowed to run across the surface to gullies which collect it and direct it into pipes which remove it as quickly as possible, as it is undesirable to allow water into conventional sub-base material.

In contrast, concrete block permeable pavements have a dual role and also act as the drainage system as well as supporting traffic loads. They allow water to pass through the surface (between each block) and into the underlying permeable sub-base (either coarse graded aggregate and/or hydraulically bound coarse graded aggregate) where it is stored and released slowly, either into the ground, to the next SUDS management stage or to a drainage system (Figure 1).

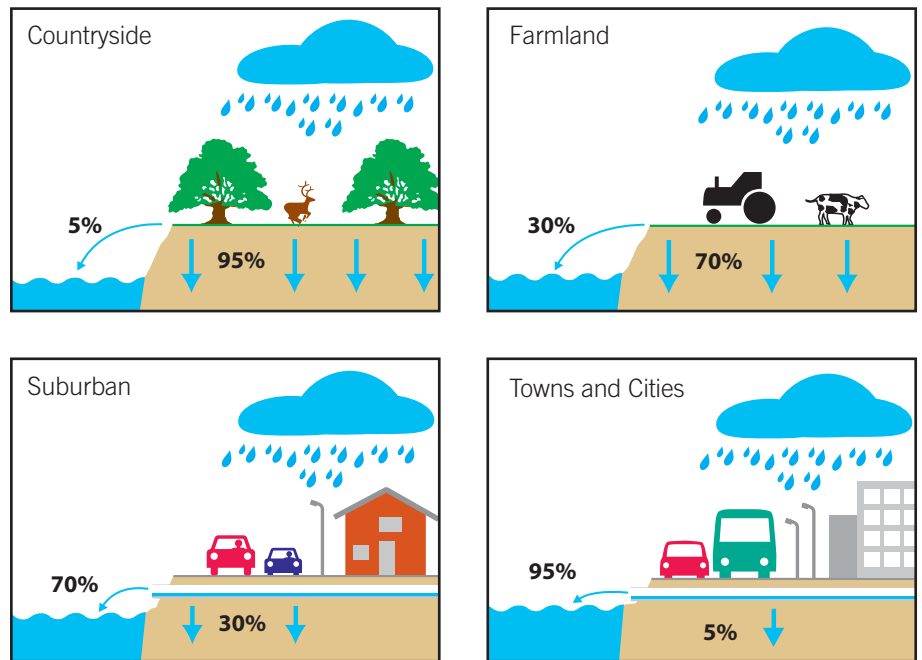

**Figure 1:** Principles of permeable pavements. As water passes through the pavement silt and other pollutants are also removed, which reduces downstream pollution.

### 3.2 SURFACE WATER RUNOFF

#### 3.2.1 WATER FLOW

With urbanisation, the increase in hard landscaping, roads, driveways, parking areas and indeed roof areas has dramatically reduced the capacity for natural, sustainable drainage. In rural areas, only 5% of the surface water runoff finds its way directly into watercourses, whereas in densely populated urban areas up to 95% of rainfall becomes surface water runoff, placing increased pressures on already overburdened drainage systems (Figure 2).



**Figure 2:** The influence of urbanisation on natural drainage at source.

This urbanisation, coupled with the fact that, since the 1960s, there has been a 50% increase in the number of 3 consecutive day storm occurrences (i.e. 3 consecutive days where a storm activity has occurred), means continuing growth in the volume of surface water runoff which we have to handle. In addition to the increased volume of water, the rate at which it runs off is much faster which increases the ‘flashiness’ of watercourses.

As an illustration, Figure 3 depicts the pattern of an idealised storm. Here, the early stages begin as drizzle, increasing to the centre of the bell shape representing the heaviest part of the storm. The scale and duration are, in this instance, irrelevant to the shape and are for illustrative purposes only. The cumulative effect of three consecutive storms of the same duration and peak intensity is shown in Figure 4. The much greater volume of runoff, which needs to be catered for, is highlighted by the larger, taller curve.



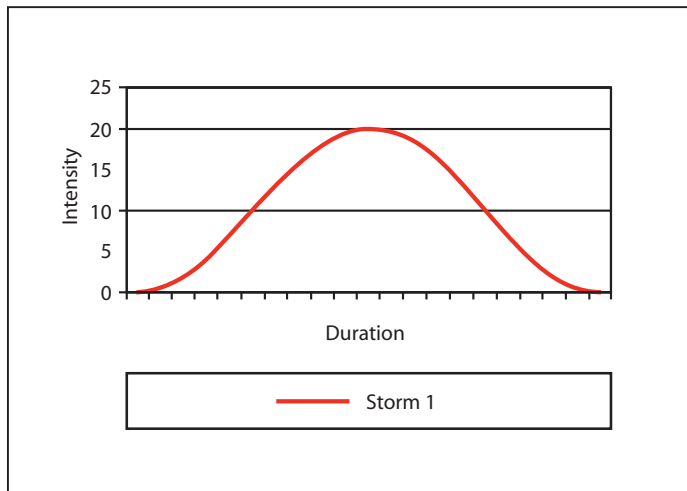

Figure 3: Typical storm pattern.

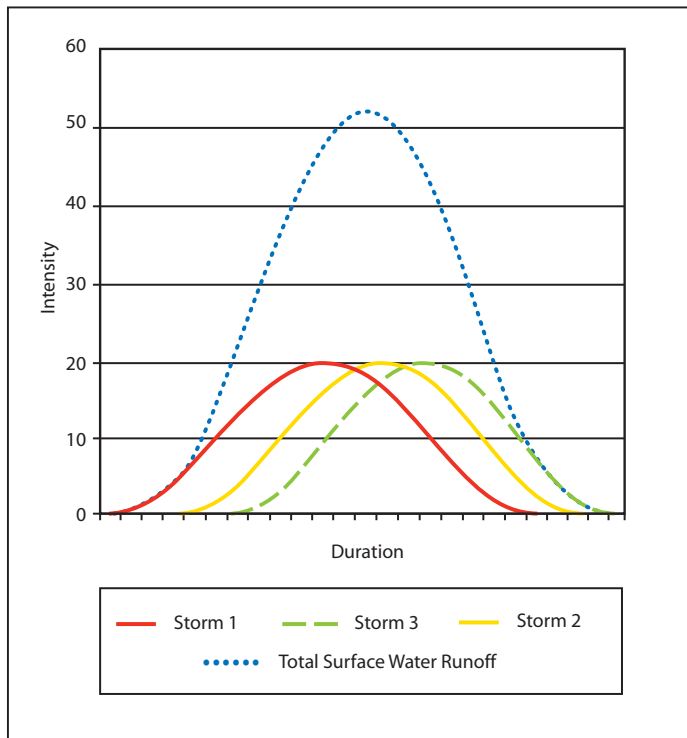

Figure 4: Cumulative effect of consecutive storms.

Surface water runoff from impervious pavements occurs in the following manner: falling rain first wets the surface and, as the rainfall increases, water begins to pond in surface depressions until these have filled. The surface water then moves towards drainage points or discharges into watercourses. This moving water becomes the surface water runoff, whilst the water remaining in puddles will be absorbed or will evaporate. The amount of time taken for the water to move from the farthest point where rain hits the ground to entering the drainage system is known as the ‘time of entry’. In the case of traditional impermeable surfaces the distance from the farthest point to a gulley inlet may be some 20 to 30m. In contrast, with concrete block permeable pavements the time of entry is just the time which it takes the droplet of rain to hit the block and move to the joint or void between adjacent

blocks. As this time is short, standing water on the pavement and surface ponding are virtually eliminated. This is demonstrated in practice and is most noticeable when comparing permeable pavements and impermeable surfaces under similar conditions. There are rarely any puddles on the permeable surface compared to numerous puddles on most impermeable surfaces (Figure 5).



**Figure 5:** comparing impermeable paving (right) and concrete block permeable paving (left) under similar rain conditions.

#### 3.2.2 POLLUTION

Pollution is present on road and car park surfaces as a result of oil and fuel leaks, and drips, tyre wear, dust from the atmosphere, etc. This type of pollution arises from a wide variety of sources and is spread throughout an urban area and is known as diffuse pollution. Rainfall washes the pollutants off the surface.

Conventional drainage systems, as well as attenuation tanks, effectively concentrate pollutants, which are flushed directly into the drainage system during rainfall and then into watercourses or groundwater. The impact of this is to reduce the environmental quality of watercourses.

The '*Water Framework Directive*' (European legislation) requires that surface water discharges are managed so that their impact on the receiving environment is mitigated. The objective is to protect the aquatic environment and controlling pollution from diffuse sources such as urban drainage which will be a key aspect that will effectively preclude the use of the traditional approach to drainage.

#### 3.2.3 CLIMATE CHANGE

There is increasing evidence that the earth's climate is changing. As a result of this rainfall patterns in the UK are likely to change with the result that:

1. Winters will become milder and wetter with more intense rainfall events

2. Some types of extreme weather such as heavy spells of rain will become more frequent.

The *'Foresight Future Flooding Report'* (Evans et al, 2004) has identified that effective drainage provision must be put in place to protect urban areas from flooding in the future.

## 3.3 BENEFITS

### 3.3.1 WATER FLOW

There are a wide range of benefits resulting from concrete block permeable paving, including the following key performance criteria:

- Water Flow – meeting the design requirements for drainage
- Water Quality Improvement – removing pollutants
- Amenity – improving the local environment.

Permeable pavements deal with surface water close to where rainfall hits the ground. This is known as 'source control' and is a fundamental part of the SUDS philosophy. They reduce the peak rate, total volume and frequency of runoff and help to replicate green-field runoff characteristics from development sites. They also cleanse and remove pollution from runoff. Thus they help to deal with the problems caused by normal drainage that were identified in the previous section.

Permeable pavements may be used for practical, economic and environmental reasons as well as to satisfy planning and building regulation requirements. In England and Wales Part H3 of the Building Regulations requires rainwater from roofs and paving around buildings to discharge into an infiltration system (such as a System A permeable pavement, discussed later) in preference to watercourses or sewers wherever practicable. The Scottish Building Standards (Section 3 – Environment) specifically refer to drainage using suitable SUDS techniques (again, such as permeable pavements) and require pollutant removal from surface water. Permeable pavements are especially cost-effective in urban developments, where there is a need to introduce parking but insufficient space for SUDS techniques such as detention or retention ponds. Permeable pavements can be used to conserve land by combining parking with surface water handling within a single construction element.

A study by H. R. Wallingford (Kellagher and Lauchlin 2003) has confirmed that permeable pavements are one of the most space-efficient SUDS components available, as they do not require any additional land take (Figure 6).



**Figure 6:** Concrete block permeable pavements in a high density development.

Permeable pavements are particularly suited to providing a hard surface within a Sustainable Drainage System (SUDS) framework, although they are also effective in isolation. SUDS is a design philosophy which uses a range of techniques to manage surface water by attenuation and filtration. Permeable pavements are particularly effective at the head of a SUDS management train, as they have the capacity to mitigate pollution events before affected water passes to more sensitive environments, unlike attenuation tanks.

They are also very useful in areas where sewers flow at capacity during storms owing to an increase in impervious cover from parking or buildings. In these situations, replacing existing pipes with larger ones is often not economical, or even allowable because it merely transfers the additional runoff downstream, where this may increase erosion and flooding problems, unlike attenuation tanks.

Independent research, commissioned by Interpave and carried out by specialist consultants Scott Wilson (Interpave, 2006), considered over 250 different cases and compared concrete block permeable pavements with conventional block paving, asphalt and in situ concrete. By taking into account drainage requirements, the economic advantages of concrete block permeable pavements – both in terms of initial construction cost and whole life costs – were clearly demonstrated for construction methods and material costs current at the time. It is recommended that project-specific costings including drainage are carried out to demonstrate the benefits of concrete block permeable pavements.

Other benefits for permeable pavements include enabling level car parking areas for supermarkets making it easier to control trolleys, eliminating ponded water and reducing risk of ice forming on the surface. In applications such as these, the absence of rain splashing from standing water is an added benefit.

## 3.3.2 WATER QUALITY IMPROVEMENT

Concrete block pavements are very effective at removing pollution from runoff, unlike attenuation tanks. The pollutants may either remain on the surface (particularly with zero gradients) or may be flushed into the underlying pavement layers where many of the pollutants are filtered and trapped or degrade over time (Figure 7).

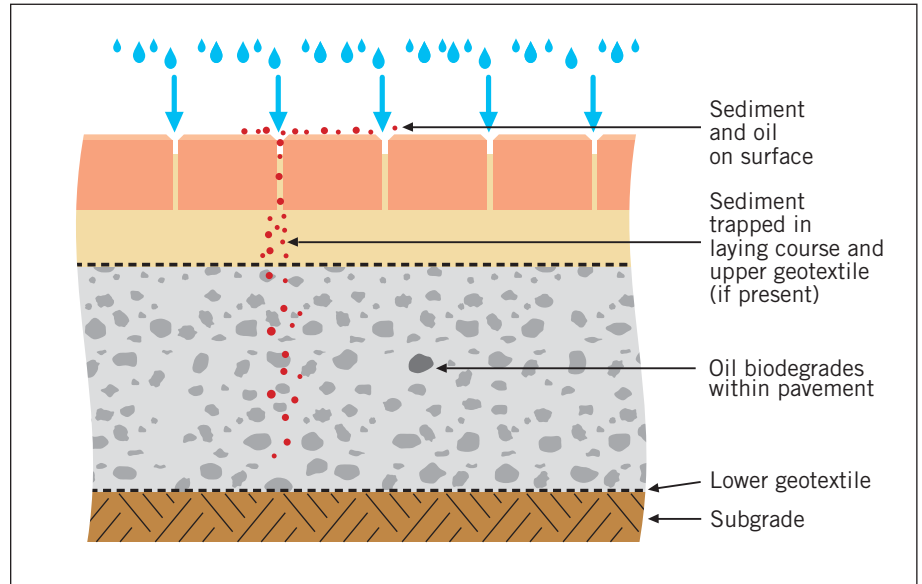

**Figure 7:** Fate of pollutants in a permeable pavement.

Hydrocarbons may degrade but other contaminants, such as heavy metals, do not break down and remain within the pavement structure for a long period of time, making permeable pavements ideal for areas where vehicles are stored or maintained. Further information on pollution removal is provided in CIRIA Reports C 697, C 609 and C 582 (CIRIA 2007, 2004 and 2001). The research that has been undertaken demonstrates the effectiveness of permeable pavements in reducing pollution. They can for example remove between 60% and 95% of total suspended solids (i.e. silt) and 70% to 90% of hydrocarbons. When subjected to low level oil drips, such as in car parks, the pavements can continue to biodegrade the hydrocarbons indefinitely.

*'Pollution Prevention Guideline' PPG 3 (Environment Agency, 2006) identifies the beneficial performance of permeable pavements in removing pollution from runoff. It states that: "Techniques that control pollution close to the source, such as permeable surfaces or infiltration trenches, can offer a suitable means of treatment for runoff from low risk areas such as roofs, car parks, and non-operational areas."*

Oil separators are not required when permeable pavements are used. Indeed permeable pavements are more effective at removing a wider range of pollutants from runoff than oil separators (CIRIA, 2004). If additional treatment is required for higher risk areas it is normally more effective to use green SUDS methods such as swales or wetlands, as these also treat a wider range of pollutants.



## 4. PROPERTIES

### 4.1 TYPES OF CONCRETE BLOCK

Various types of concrete block paving have been designed specifically for use in permeable pavements, full details of which are available from Interpave members (details can be found on [www.paving.org.uk](http://www.paving.org.uk)). These designs incorporate enlarged joints created by larger than conventional spacer nibs on the sides of each paving block or voids generated by geometric block shapes (Figure 8). Joints or voids are subsequently filled with a single sized joint filling material. The joint filling material size and specification is specific to each product and Interpave members should be consulted for further advice. However the joint material will be a crushed rock that is fine gravel sized. Conventional jointing sand is not suitable as a medium for surface water to pass down through the pavement. For further information on specific block types, contact the relevant Interpave members.

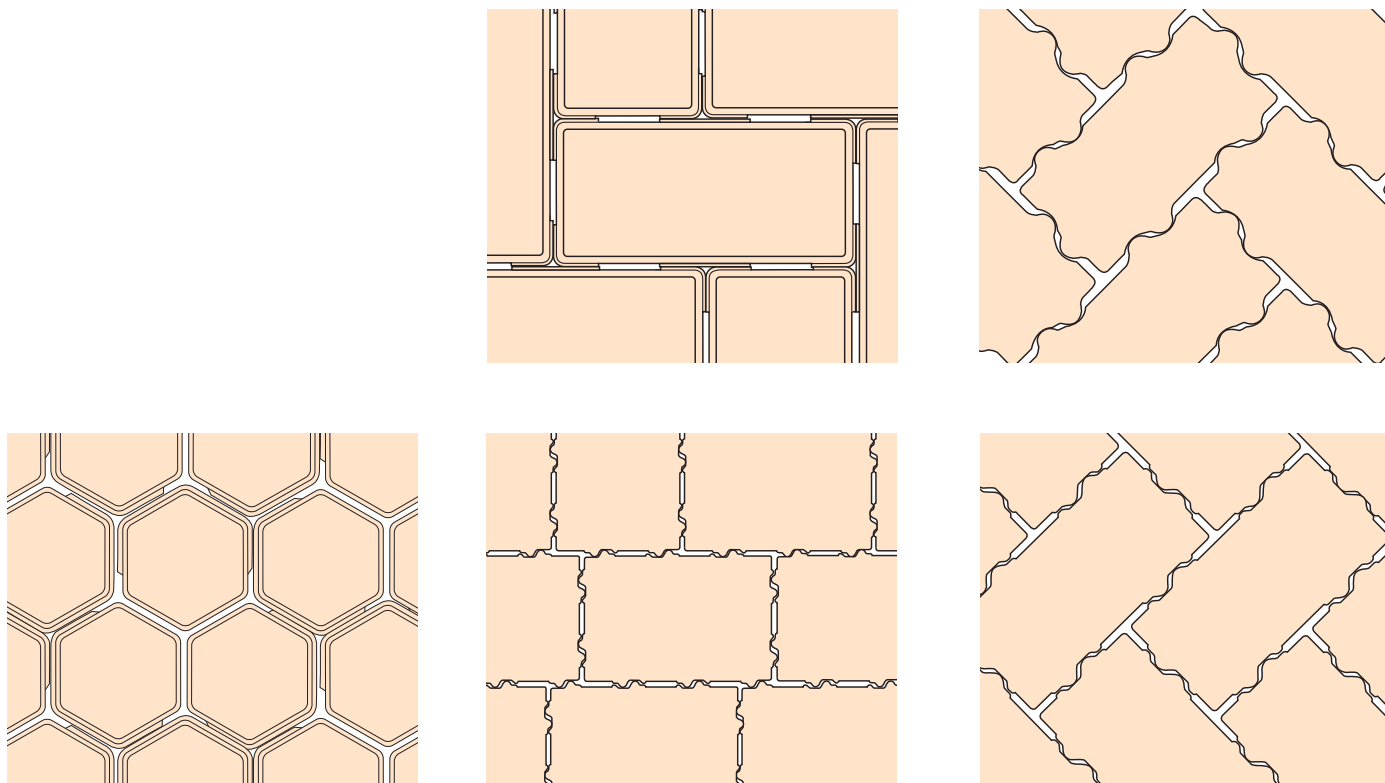

Figure 8: Examples of block types available from Interpave Members.

### 4.2 TYPES OF PERMEABLE PAVEMENT

There are three principal systems suitable for permeable pavements using concrete block paving as the wearing surface – described here as Systems A, B and C as defined in *'The SUDS Manual'* (CIRIA 2007). The following drawings are indicative only and full construction drawings can be found later in the Guide.



#### 4.2.1 SYSTEM A – TOTAL INFILTRATION

This system (Figure 9) allows all water falling onto the pavement to infiltrate down through the joints or voids between the concrete blocks, passing through the constructed layers below and eventually into the subgrade. Some retention of the water will occur temporarily in the permeable sub-base layer allowing for initial storage before it eventually passes through.

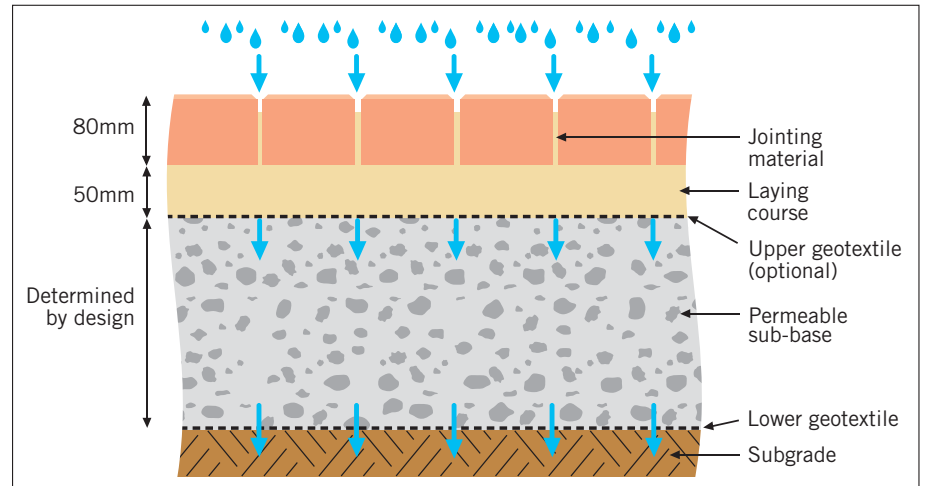

Figure 9: System A – total infiltration.

System A is sometimes known as ‘Zero Discharge’, as no additional water from the new development is discharged into traditional drainage systems, therefore the need for pipes and gulleys is eliminated resulting in cost savings. In some situations, overflows may be needed to provide support drainage when the design capacity is exceeded or as secondary drainage to allow for the system becoming less efficient in the event of silting.

#### 4.2.2 SYSTEM B – PARTIAL INFILTRATION

Similar to System A, System B can be used in situations where the existing subgrade may not be capable of absorbing all the water. This system can, therefore, prevent the existing soil from losing its stability. In System B (Figure 10) outlet pipes are connected to the permeable sub-base and allow the excess water to be drained to other drainage devices, such as sewers, swales or watercourses.

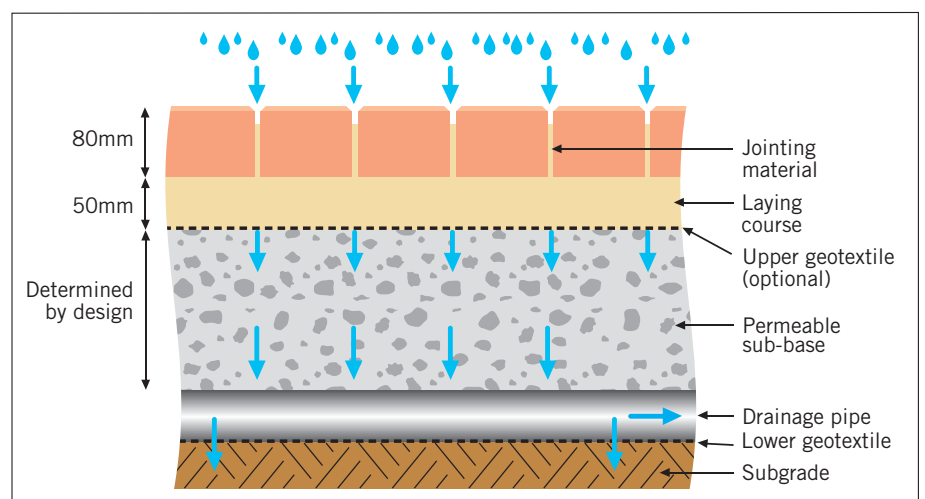
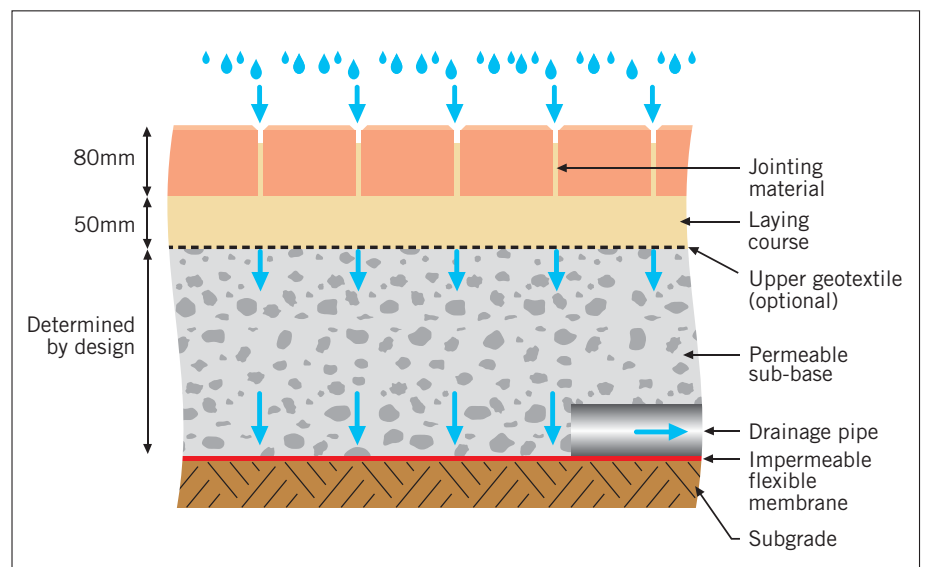

Figure 10: System B – partial infiltration.

A fixed amount of water is allowed to infiltrate down through the system – which, in practice, often represents a large percentage of the rainfall. The excess is collected and eventually discharged into sewers or watercourses, with a peak discharge rate that is agreed with the regulators (Environment Agency or SEPA). This is one way of achieving the requirement for reducing the volume of runoff and will most likely remove the need for any long term storage (see later sections).

#### 4.2.3 SYSTEM C – NO INFILTRATION

This system (Figure 11) allows for the complete capture of the water using an impermeable, flexible membrane placed on top of the subgrade level and up the sides of the permeable sub-base to effectively form a storage tank. It is used in situations where the existing subgrade has a low permeability or low strength, and would therefore be damaged by the introduction of additional water. It can also be used for water harvesting or to prevent water soaking into the ground in sensitive locations such as water extraction zones. Outlet pipes are constructed through the impermeable membrane at suitable locations to transmit the water to sewers, watercourses or treatment systems. Importantly, the outlet pipes are designed to restrict flow so that water is temporarily stored within the pavement and discharge slowed.

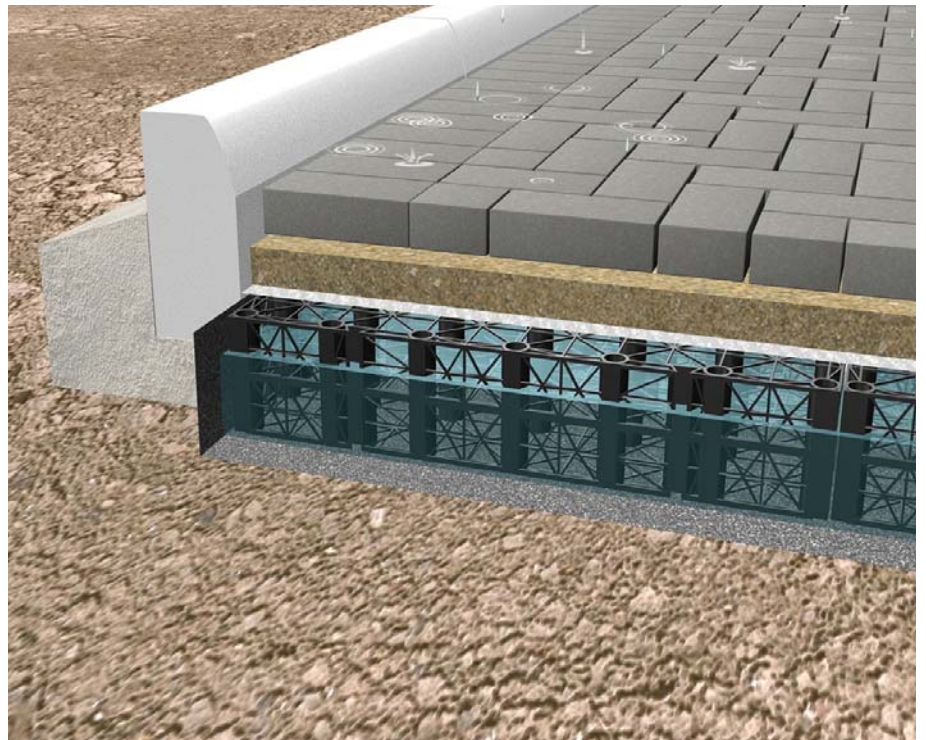

**Figure 11:** System C – no infiltration.

System C is particularly suitable for contaminated sites, as it prevents pollutants from being washed further down into the subgrade where they may eventually be washed into the groundwater. It can also act as an underground retention/detention zone and, in some instances, the stored or captured water can be collected, cleansed, stored and reused for other purposes, such as flushing toilets (i.e. 'rainwater reuse') or for irrigation (see Rainwater Harvesting). Extensive research summarised in CIRIA C 609 has demonstrated that permeable pavements will significantly reduce pollution but there may also be a need to treat the water before use in some cases. In the majority of situations, this is not normally required for toilet flushing and irrigation.

### 4.3 PERMEABLE SUB-BASE REPLACEMENT SYSTEMS

There are a number of permeable sub-base replacement systems on the market that can be incorporated into permeable pavements. They usually consist of a series of lattice plastic, cellular units, connected together to form a raft structure that replaces some or all of the permeable sub-base, depending upon the anticipated traffic loading (Figure 12). They may be manufactured using recycled plastic.



**Figure 12:** Permeable sub-base replacement system.

The water storage capacity is higher than with conventional granular systems and, consequently, approximately 30-40% of the depth of a granular permeable sub-base pavement is needed for the hydraulic design of the pavement. This can lead to a shallower excavation and reduced material disposal to landfill which, in turn, makes them particularly economical for 'brown field' and contaminated sites. The design of these systems is more specialised than conventional permeable pavements and advice should be sought from the suppliers/manufacturers of these systems. They are also useful to form inlets or outlets to and from the permeable sub-base as they can be placed at a much shallower depth below trafficked areas than most pipes.

### 4.4 RAINWATER HARVESTING

Rainwater harvesting is a system where rainwater from roofs and hard surfaces is collected and used in or around buildings. The water can be used for a range of non-potable uses such as toilet flushing and watering gardens. The runoff used for harvesting needs to be of reasonable quality and should be free of debris and sediments. Permeable pavements will provide filtration to achieve this.

The water can be stored in the permeable sub-base below a permeable concrete block pavement (as referred to in *'The SUDS Manual'*). It is however very important to note that the storage volume for reuse is normally separate to that for rainfall attenuation. This is because the two types of storage have different requirements:

- Rainwater reuse – must be full for as much of the time as possible so that water is available for use.
- Stormwater attenuation – must be empty most of the time so that it can temporarily store water from rainfall events.

Guidance on the design of rainwater reuse systems is provided in CIRIA Report C 539 (CIRIA, 2001) and in *'The SUDS Manual'*.

An example scheme is shown in Figure 13, installed at a new school in Milton Keynes.

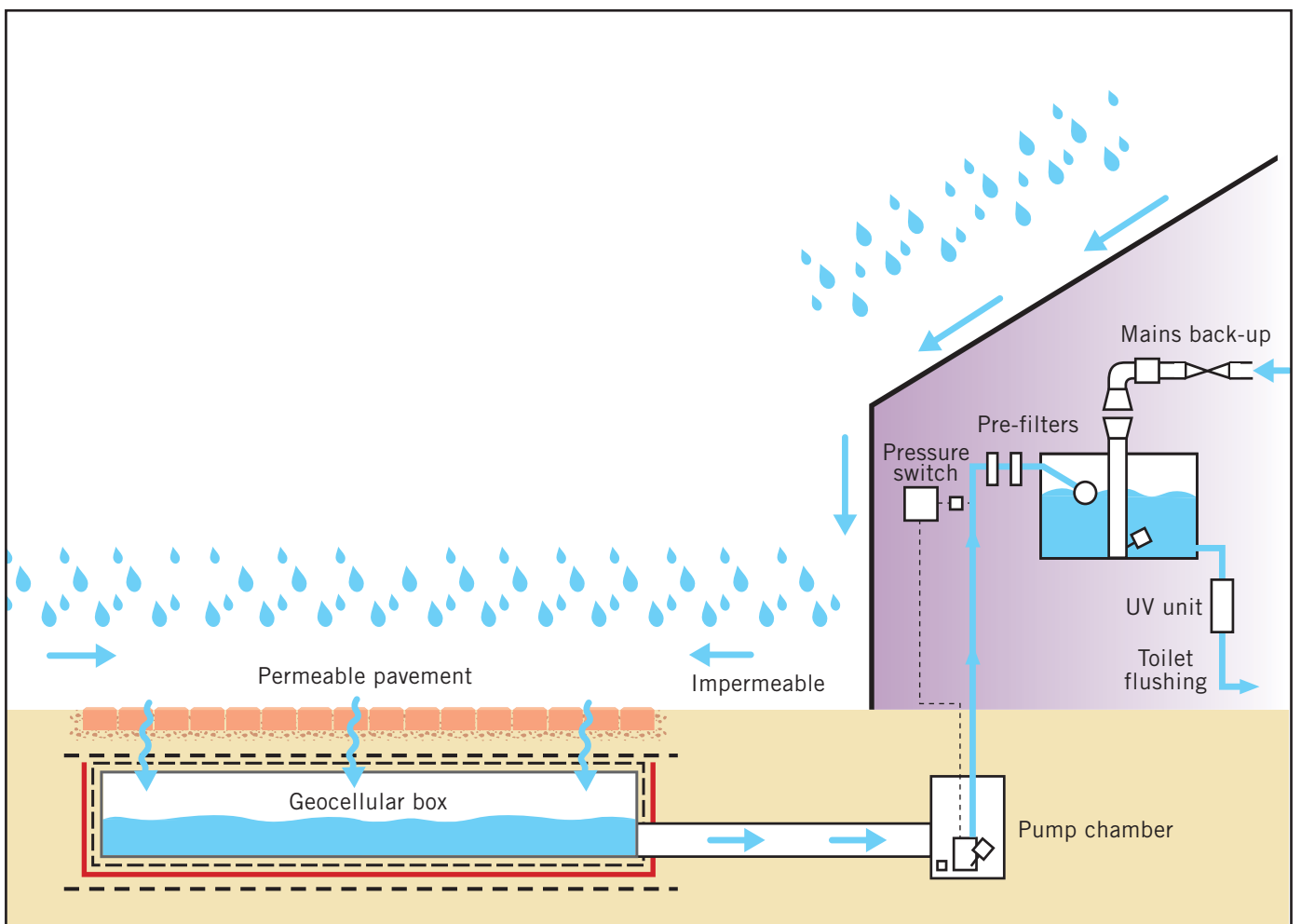

**Figure 13:** Example layout of rainwater harvesting system at a Milton Keynes school.



The permeable pavement collects rainfall, runoff from adjacent hard play surfaces and roof water. This water passes through the joints in the block paving, bedded on a permeable laying course and a filter geotextile, directly into a geocellular storage box. The polypropylene geocellular box is enclosed in a second filter geotextile, with a waterproof polypropylene geomembrane to the sides and base, to form an open topped tank. Water can overflow at the tank edges into an existing SUDS system. This arrangement filters and treats the water before it passes into storage or overflows to the SUDS system. Cleaned rainwater is delivered, via a pump chamber, from the storage box to a header tank for toilet flushing in the school buildings.

Permeable pavements reduce the volume and frequency of runoff from sites. Therefore for the purposes of rainwater harvesting it is recommended that conservative estimates of runoff from permeable areas are used. A runoff coefficient of 40% is recommended for rainwater harvesting design, based on guidance provided in *'The SUDS Manual'*.

#### 4.5 RETROFITTING

Permeable pavements can be retrofitted to sites (Figure 14), for example during refurbishment work or as part of a planned operation to reduce stormwater runoff and improve quality.

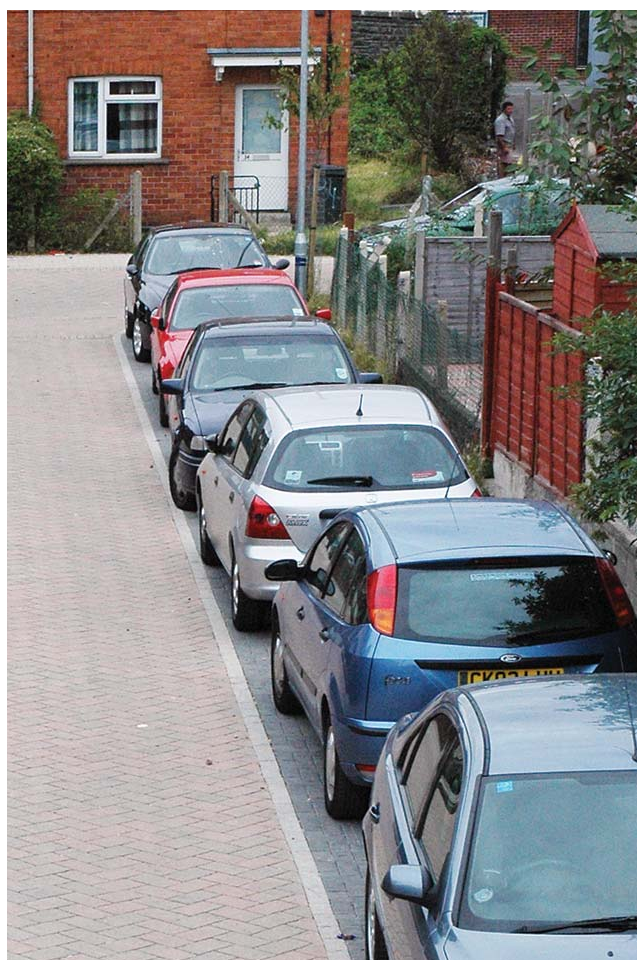

**Figure 14.** Retrofitted concrete block permeable pavements at a Home Zone in Bristol, subsequently adopted by the local authority.

## 5. SELECTION OF A PAVEMENT SYSTEM

### 5.1 SUBGRADE PERMEABILITY

One of the key criteria in selecting a pavement system is subgrade permeability, which is established from appropriate tests on site. Infiltration tests for traditional soakaways are usually carried out at depths greater than 1m below ground level. Permeable pavements infiltrate water into the ground at much shallower depths than traditional soakaways and therefore infiltration tests should be carried out close to the final formation level of the pavement. This usually means that the tests are much shallower (less than 1m depth) and use a lower head of water, to replicate the performance of the permeable pavement. Table 1 recommends appropriate pavement systems for a range of subgrade conditions, including permeability derived from infiltration tests, while Table 2 gives guidance on soil classification.

		System A total infiltration	System B partial infiltration	System C no infiltration
permeability of subgrade defined by coefficient of permeability k (m/s)	$10^{-6}$ to $10^{-3}$	✓	✓	✓
	$10^{-8}$ to $10^{-6}$	✗	✓	✓
	$10^{-10}$ to $10^{-8}$	✗	✗	✓
highest recorded water table within 1000mm of formation level		✗	✗	✓
pollutants present in subgrade		✗	✗	✓

**Table 1:** Guidance on selection of a pavement system.

Soil classification	Typical range for coefficient of permeability K (ms)	Typical range of CBR values
heavy clay	$10^{-10}$ to $10^{-8}$	2 to 5
silty clay	$10^{-9}$ to $10^{-8}$	3 to 6
sandy clay	$10^{-9}$ to $10^{-6}$	5 to 20
poorly graded sand	$5 \times 10^{-7}$ to $5 \times 10^{-6}$	10 to 40
well graded sand	$5 \times 10^{-6}$ to $10^{-4}$	10 to 40
well graded sandy gravel	$10^{-5}$ to $10^{-3}$	30 to 80

**Table 2:** Soil classification guide.

### 5.2 SITE CHARACTERISTICS

There are a number of other factors that need to be considered when choosing which is the most appropriate system for a site:



## 5.2.1 GROUND WATER TABLE LEVEL

For Systems A and B, the highest recorded groundwater level must be greater than 1000mm below the bottom of the permeable sub-base. This is to allow filtration of pollutants in the soil below the pavement and also to prevent groundwater rising and reducing the available storage in the permeable sub-base.

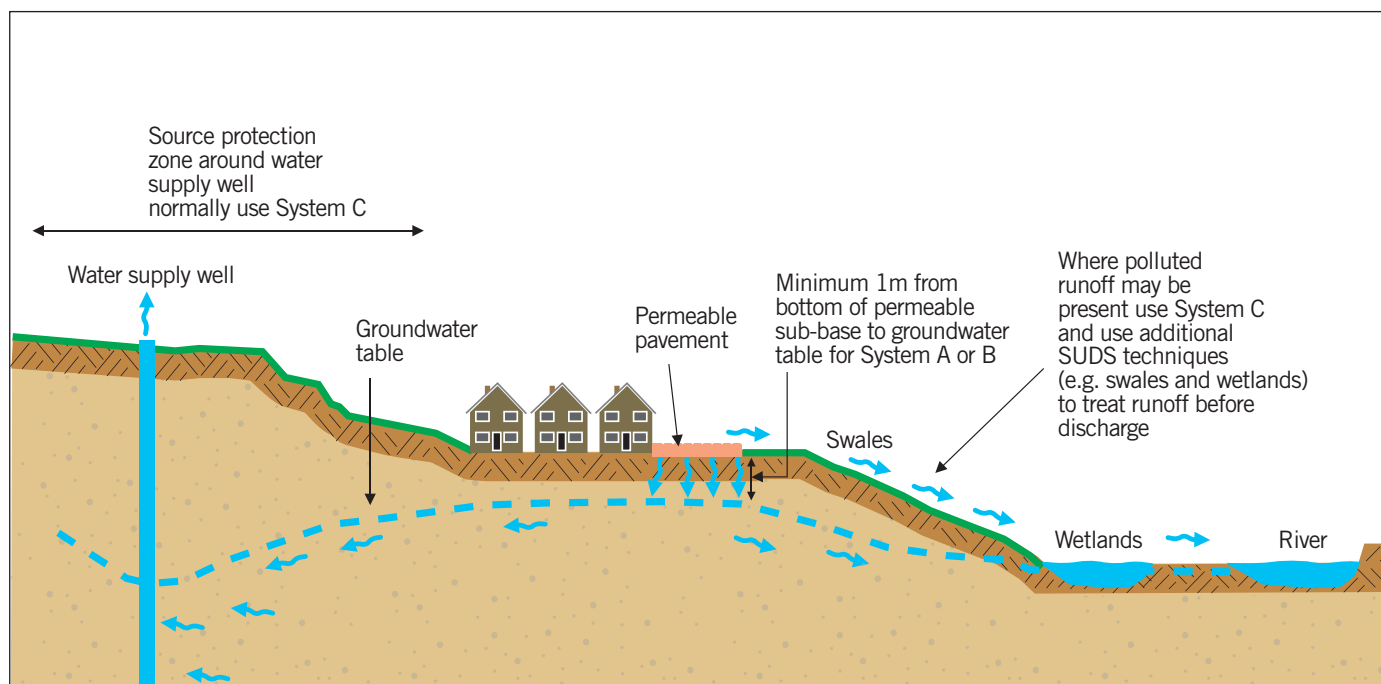

Figure 15: Pollution prevention considerations.

## 5.2.2 POLLUTION PREVENTION

There are defined areas around public water supply boreholes known as source protection zones (Figure 15). In these areas the use of System A permeable pavements may not be appropriate and System C may be necessary. The use of permeable pavements in these locations should follow the general advice provided in the latest version of *'Groundwater protection: Policy and practice'* published by the Environment Agency. Detailed risk analysis following the guidance in Environment Agency Report P2-174 (Environment Agency, 2001) can be undertaken to confirm whether a permeable pavement will be acceptable on its own or if additional treatment stages are required. In a recent example, the use of a permeable pavement within a source protection zone was shown to pose a lower risk to the water supply borehole than the use of a large soakaway outside the zone. This was because the permeable pavement treated the runoff to remove pollution and dispersed the flows over a wide area at a low intensity when compared to a traditional soakaway.

If any site is classified as a stormwater hotspot and there is any risk that contaminated stormwater can infiltrate the ground water, infiltrating permeable pavements on their own are not recommended and either System C should be used or additional treatment stages provided, such as wetlands (see Figure 15, Table 1 and '*Pollution Prevention Guideline No 3*' – Environment Agency, 2006). Such applications include: vehicle scrap yards, recycling facilities, petrol stations, service and maintenance facilities, and other locations that handle potentially polluting substances.

### 5.2.3 DISCHARGE CONSENTS

Drainage discharges from some sites to either the ground or to surface watercourses may require a discharge consent. Details of which sites are not likely to require a consent are provided in the '*Interim Code of Practice for Sustainable Drainage Systems*' published by the National SUDS Working Group, (2004). Early consultation with the Environment Agency is recommended. The discharge of surface water in Scotland is a controlled activity under '*The Water Environment (Controlled Activities) (Scotland) Regulations 2005*'. Under these regulations surface water discharges to ground or water must be authorised by The Scottish Environment Protection Agency (SEPA). Authorisation is risk-related, with discharges from buildings, including hard standings, being classed as low risk if they are carried out in accordance with the General Binding Rules.

### 5.2.4 PROXIMITY TO BUILDINGS

Permeable pavements may be used close to buildings as they allow dispersed infiltration similar to natural vegetation: so, the 5m guidance provided in the Building Regulations for soakaways (which, in contrast, provide a single point discharge) need not apply, as has been clarified by the government. However, if a concentrated outflow (such as roof drainage terminal) is used within the pavement, this should be at a sufficient distance to ensure the stability of the building is not affected. On many sites, even when the flow from roofs is considered, the ratio of area drained to the area of the soakaway for a permeable pavement is much less than that from a traditional soakaway (between 3:1 and 6:1 for a permeable pavement compared to 30:1 and 300:1 for a traditional soakaway). Thus water flows from the base of permeable pavements are much less concentrated.

## 5.3 OTHER CRITERIA

System C pavements can also be used most effectively as part of a water-harvesting scheme. Concrete block permeable pavements are also particularly useful where a hard surface is required in close proximity to trees and other planting, as water flow to roots can be maintained. In addition to water infiltration applications, concrete block permeable pavements have also been used to prevent the build-up of gases below ground, for example with development over land-fill sites for dispersal of methane.

Permeable pavements are a very flexible method of providing drainage suitable for a wide variety of sites including areas that are trafficked by HGVs. An holistic approach to project design is important when incorporating permeable paving. The needs of vehicular traffic and pedestrians should be balanced against drainage requirements. As with any drainage system, overflow routes to cater for extreme events should be planned. It is particularly important to organise statutory service runs in relation to permeable and impermeable paved areas to cater for future maintenance of the services. Guidance on layouts and adoption by highway authorities can be found in Interpave's '*Understanding Permeable Paving*' document via [www.paving.org.uk](http://www.paving.org.uk).

To obtain the best performance and minimise problems during construction the following factors should be considered:

- Do not use permeable pavements where there will be very heavy silt loads from the proposed use (e.g. stockpiling sawdust or large recycling centres subject to heavy silt loads).
- It is possible to construct part of an area in impermeable materials that drain onto the concrete block permeable pavement. For example car parking bays are often constructed using permeable paving and the access ways are impermeable construction.
- Open graded permeable sub-base below the permeable pavement should not be used by construction traffic, otherwise it will clog. There are a number of solutions to this issue discussed later and one of these is to avoid using permeable pavements in the areas where construction traffic will be heaviest.
- Design of permeable pavements must take into account the overland flow routes of water when the design capacity is exceeded. Although exceedance will result in flooding of some areas of a site, the flows should be routed to prevent flooding of buildings for events that are well in exceedance of the capacity of the system. Further guidance is provided in CIRIA Report C 635 (CIRIA, 2006).

### 5.4 SERVICE CORRIDORS

It is not necessary to design all surface areas as permeable, as CBPP can cope with runoff from adjacent impermeable surfaces, including roofs, based on a rule of thumb ratio of 2:1 impermeable: permeable. With careful layout design, services and utilities can be located within conventional impermeable areas, service corridors or verges, avoiding the CBPP, negating the need to excavate and removing the risk of disturbing the CBPP to access these services. This approach can also form a key part of the overall layout design both visually and technically, allowing designers to use their imaginations and realise the aspirations of the *'Manual for Streets'*. For example, an impermeable central carriageway might be employed to contain services, visually differentiated from CBPP parking bays (Figure 16). Alternatively, impermeable service crossings could also be used as pedestrian ways, clearly differentiated from CBPP intended for vehicles (Figure 17).

**Figure 16:** Plan of an alternative layout with services in an impermeable road.

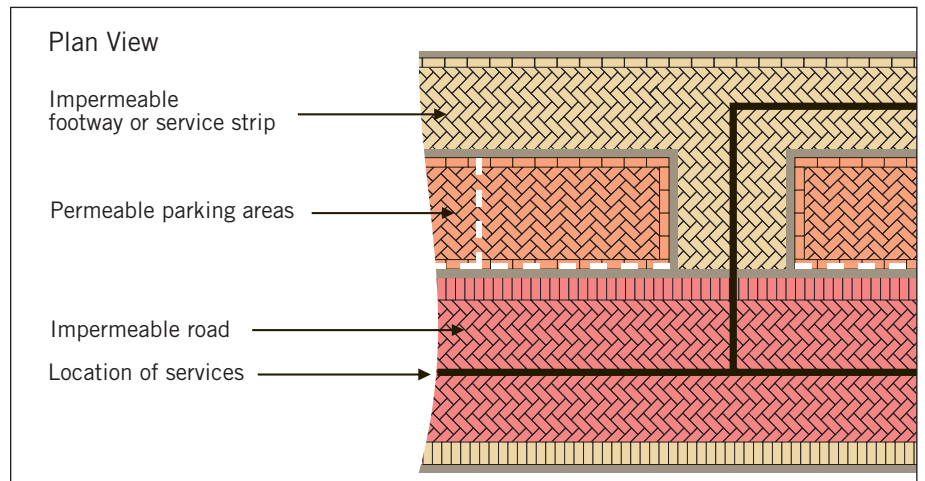

**Figure 17:** Plan and cross section of a typical service crossing using impermeable pavement construction within a concrete block permeable pavement.

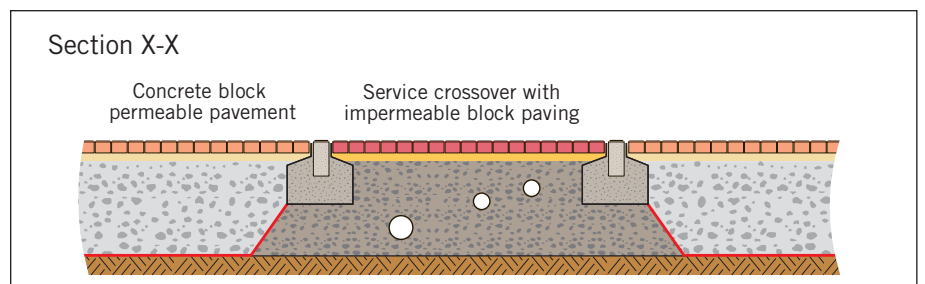
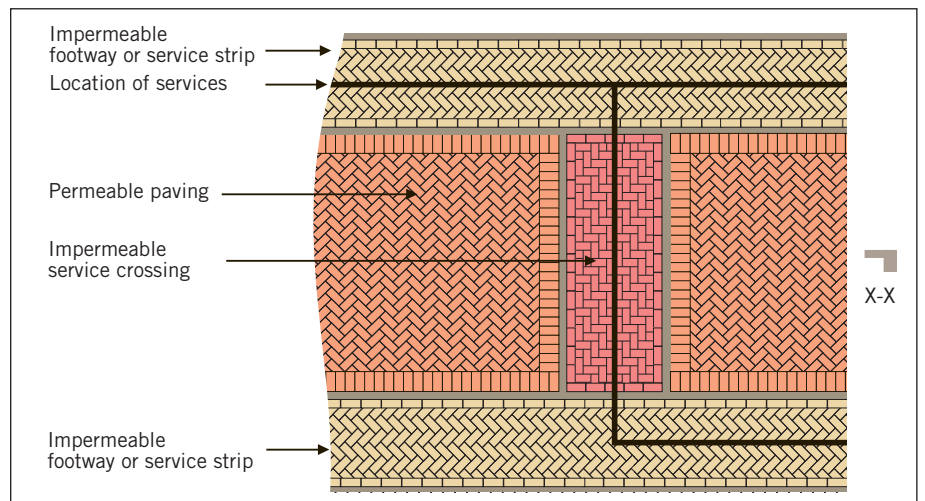

## 6. STRUCTURAL AND HYDRAULIC DESIGN

### 6.1 DESIGN CRITERIA

Permeable pavements must be designed to achieve two aims:

- Support the traffic loads
- Manage surface water effectively (i.e. provide sufficient storage).

Therefore there are two sets of calculations required and the greatest thickness of permeable sub-base from either calculation is used as the design thickness (Figure 18).

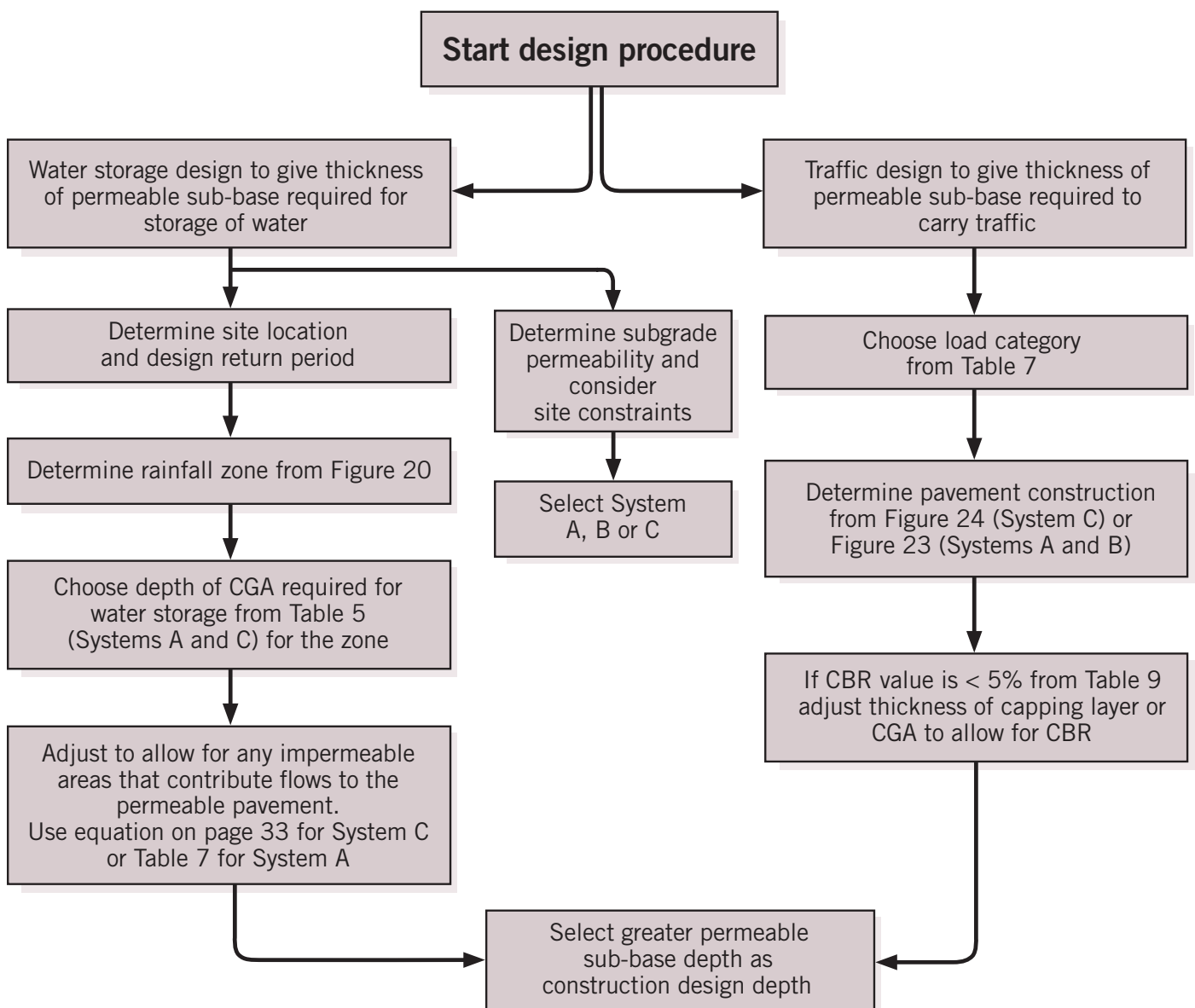

**Figure 18:** Design of concrete block permeable pavements.

## 6.2 WATER STORAGE DESIGN

For most situations it is not feasible to provide a structure which will withstand the greatest rainfall that has ever occurred. It is often more economical to tolerate a periodic failure than to design for every intense storm. For these purposes, data providing return periods of storms of various intensities and durations are essential. The return period is defined as a period within which the depth of rainfall for a given duration will be equaled or exceeded once on the average.

There are three key overriding, general principles that should be followed when designing any drainage system:

- Ensure that people and property on the site are protected from flooding
- Ensure that the impact of the development does not exacerbate flood risk at any other point in the catchment of the receiving watercourse.
- Manage overland flow to ensure buildings are not flooded.

The most up to date guidance on the hydraulic design of sustainable drainage systems is provided in '*The SUDS Manual (CIRIA Report C 697)*'. The SUDS Manual recommends a number of design criteria for the hydraulic performance of SUDS that are intended to reduce the **frequency, peak rate** and **total volume** of runoff from a site, as well as remove pollution from the runoff. This goes beyond previous requirements that have mainly concentrated on reducing the peak rate of runoff. The latest requirements are intended to provide drainage systems with outflow characteristics closer to those of a natural site and are also a requirement of Planning Policy Statement PPS 25.

The main requirements in the SUDS Manual are:

- Provide source control (i.e. control rainfall as close as possible to the point at which it hits the ground).
- Remove pollution from the first 10mm to 15mm of runoff.
- Provide interception storage to reduce the frequency and volume of runoff from a site. The requirement is to prevent runoff from occurring for all events up to 5mm of rainfall.
- Provide long term storage to reduce the volume of water flowing into rivers at critical times. The requirement is to control the volume of runoff so that it is similar to the volume of water flowing from a green-field site.
- Provide attenuation storage to reduce the peak runoff rate from a site so that is closer to green-field rates.



- Allow for climate change.

Concrete block permeable pavements are an ideal solution for achieving all the requirements listed above.

### 6.2.1 CLIMATE CHANGE

It is generally accepted that the earth's climate is changing. The most recent studies have predicted that:

- Winters will become milder and wetter with more intense rainfall events.
- Summers will be hotter and drier.
- Heavy rainfall events will become more frequent.

The '*Foresight Flooding Future Report*' (Evans et al 2004) concluded that effective land management (including drainage) must be put into place to protect urban areas from flooding in the future. To allow for climate change the rainfall intensity should be increased. The SUDS Manual suggests a range of factors of between 5% and 30% but the Environment Agency and SEPA often ask for an increase of 20% on the 1 in 100 year rainfall intensity.

### 6.2.2 UNITS

One of the most common mistakes made when designing permeable pavements is use of incorrect units. This is because the common parameters are quoted in different units and require conversion when carrying out calculations. The common units and conversions are provided in Table 3.

parameter	Units				
	mm/h	m/h	m/s	l/s	
Rainfall	20	0.02	$5.6 \times 10^{-6}$	0.0056	(note these are all/m <sup>2</sup> which is rarely stated)
Infiltration rate of soil	3.6	0.0036	$1 \times 10^{-6}$	0.001	
Flow rate into block surface (through joints) when new	4500	4.5	0.0013	1.31	

**Table 3:** Units and conversions.

### 6.2.3 INFILTRATION PAVEMENTS (SYSTEM A)

System A pavements where all the rainfall is allowed to seep into the underlying ground meet all the hydraulic design criteria listed in the SUDS Manual (interception, long term and attenuation storage), because water from the pavement does not enter a watercourse directly. System A is the preferred solution to satisfy the requirements of the Building Regulations Part H.

### 6.2.4 SOURCE CONTROL

Concrete block permeable pavements are a well recognised source control technique and thus meet this requirement. This is because rainfall only flows over one block before it is managed in the underlying permeable sub-base.

### 6.2.5 INTERCEPTION STORAGE

Studies have shown that the frequency of runoff from concrete block permeable pavements is reduced when compared to normal drainage systems. This is because the water soaks into the blocks, laying course and permeable sub-base and is then released by evaporation after the rainfall has stopped. Obviously the extent of this depends on the *antecedent* conditions (i.e. what the weather has been like beforehand). The results of various studies demonstrating the ability of permeable pavements to provide interception storage are summarised in Table 4. These show that runoff typically does not occur from permeable pavements for rainfall events up to 5mm.

Site	Reference	Interception storage (rainfall required to initiate runoff - mm)		
		Maximum	Minimum	Average
National Air Traffic Control Services, Edinburgh	CIRIA (2001)	17.2	2.6	7.3
Kinston, North Carolina	Kelly et al (2006)	>5	n/a	n/a
Sydney, Australia	Rankin and Ball (2004)	16	2.5	5 (typical from curve fit of results)

**Table 4:** Interception storage provided by permeable pavements.

In addition to providing interception storage the studies generally found that the overall flow of water out of permeable pavements was significantly reduced (between 50% and 90% when compared to impermeable asphalt surfaces). A runoff coefficient of 90% to 100% is currently used in most designs, which from the available data suggests that designs are conservative.

The use of rainwater harvesting (using the permeable pavement as the storage) can also help to achieve a reduction in runoff from small frequent events, although the exact contribution is difficult to quantify.

### 6.2.6 ATTENUATION STORAGE

The volume of permeable sub-base required for attenuation storage is typically calculated using drainage design software based on the '*Wallingford Procedure*' (HR Wallingford, 2000). For the majority of systems the volume of water that enters the permeable sub-base during a storm is greater than the volume of water that flows out. Therefore the excess water (defined below) must be stored within the permeable sub-base to prevent surface flooding (Figure 19).

Excess volume of water requiring storage = volume of rainfall – volume of outflow.

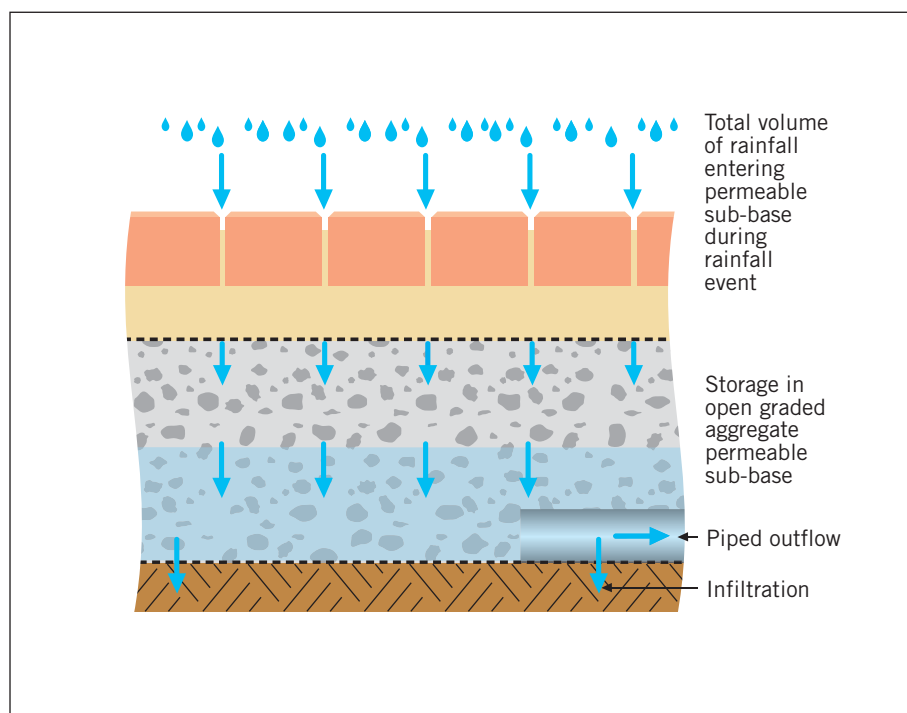

**Figure 19:** Attenuation and infiltration storage volume.

In this way the permeable pavement limits the peak rate of runoff from a site (usually to the green-field runoff rate for a site). The calculations are completed for a range of return periods and durations.

For simple preliminary designs Tables 5 and 6 can be used to size the depth of permeable sub-base below a permeable pavement. The tables are based on the hydrological rainfall regions shown on the map in Figure 20.

The rainfall for a site can be calculated using these two parameters together with the tables and graphs in the Wallingford Procedure for Europe. These calculations have been completed for the various zones and for different return periods. The results have been used to determine the thickness of coarse graded aggregate required to store water (Tables 5 and 6).

This map, developed by HR Wallingford (Kellagher & Lauchlin, 2003), defines eight hydrological zones for the UK using two parameters:

- $M_5 - 60$  is the 1 in 5 year, 60 minute duration rainfall
- “r” is the rainfall ratio (Ratio of 60 minute to 2 day rainfall for a 5 year return period).

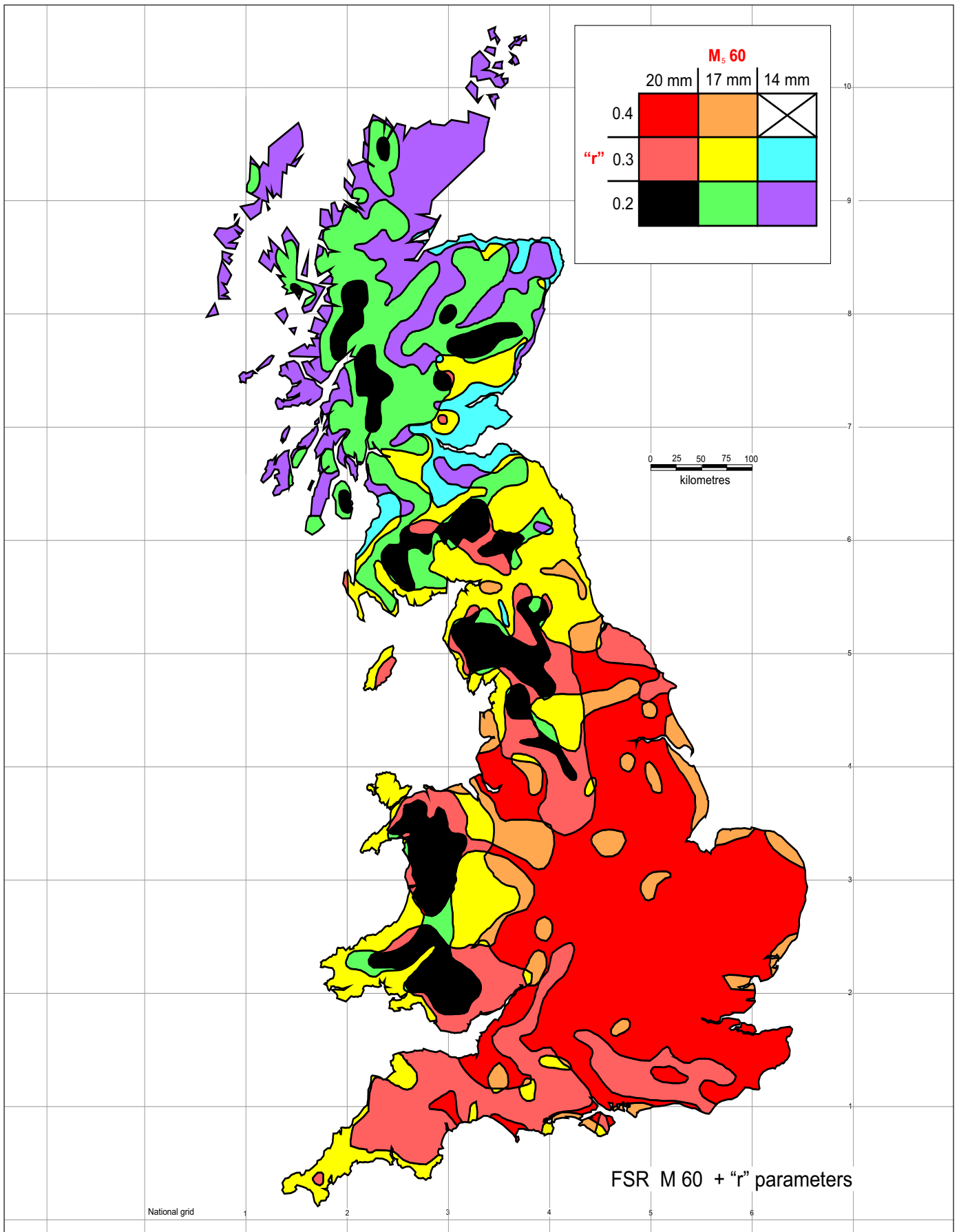

Figure 20:

- $M_5 - 60$  is the 1 in 5 year, 60 minute duration rainfall
- "r" is the rainfall ratio (Ratio of 60 minute to 2 day rainfall for a 5 year return period)

Reproduced with permission from H.R. Wallingford.



Rainfall data		Required permeable sub-base thickness (mm)		
		1 in 30 year design event	1 in 100 year event	1 in 100 year event plus 20% climate change
M <sub>5</sub> -60 = 20mm	0.4	120	160	210
	0.3	140	190	240
	0.2	180	250	310
M <sub>5</sub> -60 = 17mm	0.4	100	140	180
	0.3	110	160	210
	0.2	150	210	270
M <sub>5</sub> -60 = 14mm	0.4			
	0.3	90	130	170
	0.2	110	160	220

**Table 5:** Permeable sub-base thickness for attenuation storage (Systems A and C).

Note: Thickness assumes permeable sub-base has a voids ratio of 30%.  
 Limited discharge rate 7 l/s/ha. For System A infiltration rate greater than  $1 \times 10^{-6}$  m/s.  
 Factor of safety on infiltration rate for System A = 1.5 (based on CIRIA Report 156).  
 Assumes level site. Factor of safety on outflow for System C = 1. Assumes level site.

Table 5 is based on the following generally conservative assumptions:

- Storage is provided for development design rainfall events of 1 in 30 yr, 1 in 100 yr and 1 in 100 yr plus 20% increase for climate change but the greenfield runoff rate is always considered to be 7 l/s/ha.
- 100% runoff from the permeable pavement is assumed.

The calculations have been carried out for a range of rainfall durations up to 24 hours and the maximum depth is provided in the tables (ie the depth at the critical duration). The tables also assume that there is no impermeable area draining onto or into the permeable pavement. It is also important that permeable pavements empty relatively quickly (subject to requirements for long term storage) and the main attenuation storage volume should half empty within 24 hours after the rainfall event. This requirement was originally intended for systems designed up to a return period of 1 in 10 years and is quite onerous when applied to systems that are designed to a 1 in 100 year return period.

System B (partial infiltration) can be designed in two ways:

1. Ignore the infiltration capacity in the design for water storage and use Table 5 to design the permeable sub-base thickness.
2. Carry out site-specific design calculations allowing for the infiltration that occurs as water is stored. This is quite complex and is best carried out using one of the proprietary drainage design/analysis packages such as Micro Drainage or Info Works.

Table 5 assumes that the permeable sub-base is level. If this is not the case water will run to the low point and the available storage capacity is reduced (see Section 6.2.7).

### 6.2.7 IMPACT OF SLOPE ON AVAILABLE STORAGE

On slopes the water will run to the low end of the sub-base and the volume available for storage will be reduced (Figure 21).

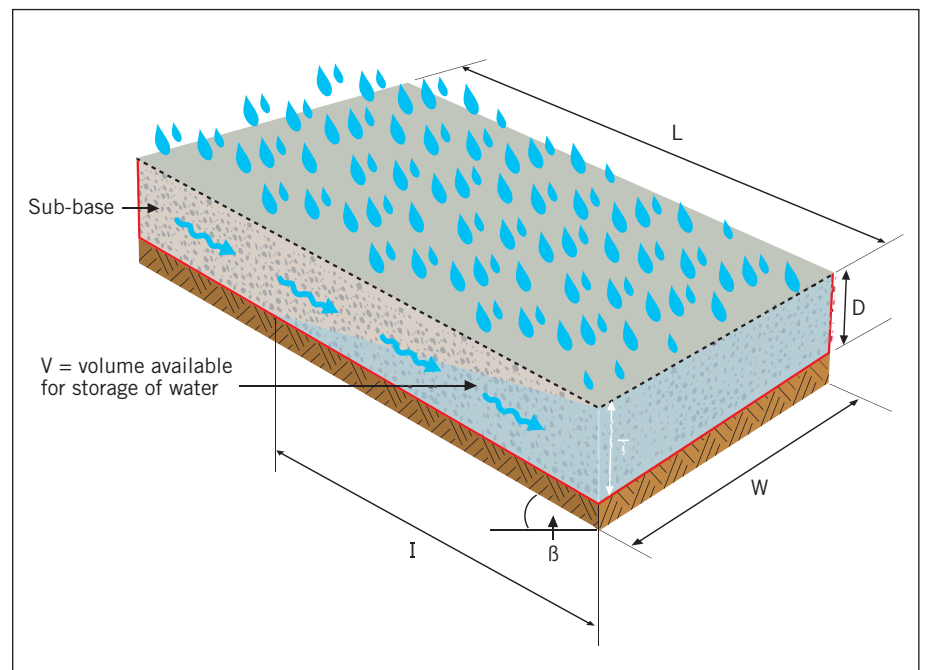

**Figure 21:** Calculation of available storage for water on sloping sites.

The available volume for storage on a level site is given by:

$$V_L = W \times L \times D$$

Where:

$V_L$  = volume of storage in sub-base on a level site

$W$  = width of pavement

$L$  = length of pavement

$D$  = depth of sub-base

For a sloping site the volume of storage is given by:

$$V_S = 0.5 \times l \times T$$

Where:

$l$  = length of sub-base where water can be stored =  $T/\tan\beta$

$T$  = thickness of sub-base measured vertically (on most shallow sloping sites this can be taken as being equal to  $D$ )

$\beta$  = slope angle

### 6.2.8 DRAINING IMPERMEABLE AREAS ONTO PERMEABLE AREAS

It is quite common to design areas where the permeable paving is required to handle runoff from adjacent impermeable areas including roofs. It is normal practice to limit the ratio of impermeable area to permeable pavement to about 2:1, as a rule of thumb and depending on site parameters (Figure 22). This is for two reasons:

1. Ratios greater than this usually result in a permeable sub-base thickness that is excessive and not cost effective
2. Silt loads onto the permeable pavement become excessive at greater ratios and the risk of the surface clogging increases.

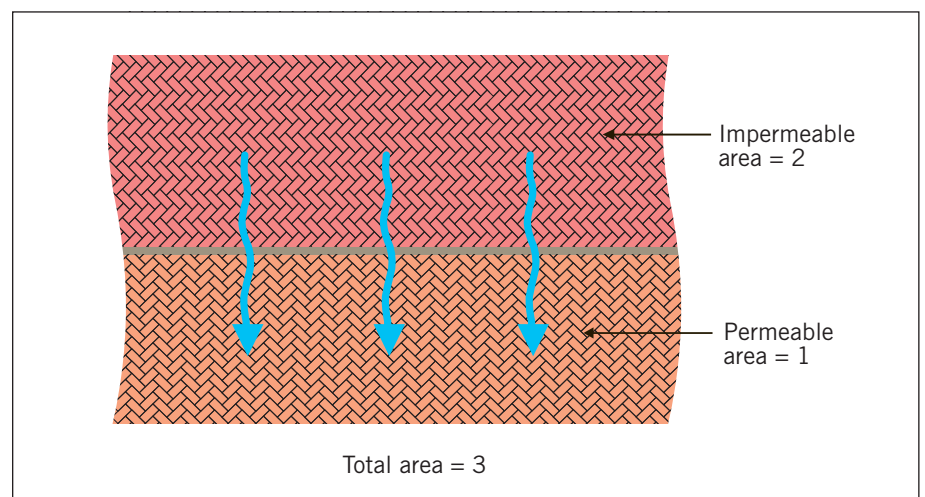

**Figure 22:** Ratio of impermeable to permeable.

As an example, if a site has a total area to be drained of 1500m<sup>2</sup> then 1000m<sup>2</sup> can be impermeable draining into 500m<sup>2</sup> of permeable block paving.

To allow for the extra rainfall being collected by the permeable pavement, the permeable sub-base thickness must be increased to give a larger storage volume. For Type C systems the thickness of sub-base can be increased using the equation below.

$$T = t (A_I + A_P)/A_P$$

Where:

T = Thickness of sub-base to store water from impermeable and permeable contributing areas

t = Thickness of sub-base to store water from permeable area only (from Table 5)

A<sub>I</sub> = Area of impermeable surfacing draining onto the permeable

A<sub>P</sub> = Area of permeable paving

For System A (infiltration) Table 6 can be used.

Rainfall data	r	Required permeable sub-base thickness (mm)		
		1 in 30 year design event	1 in 100 year event	1 in 100 year event plus 20% climate change
M <sub>5</sub> -60 = 20mm	0.4	230	340	450
	0.3	240	360	480
	0.2	260	400	530
M <sub>5</sub> -60 = 17mm	0.4	190	270	360
	0.3	190	280	380
	0.2	200	320	440
M <sub>5</sub> -60 = 14mm	0.4			
	0.3	140	210	290
	0.2	140	230	330

**Table 6:** Permeable sub-base thickness for infiltration system (System A) collecting impermeable area.

Note: thickness assumes permeable sub-base has a voids ratio of 30%.

Infiltration rate greater than 1 x 10<sup>-5</sup> m/s. Maximum ratio of impermeable to permeable is 2 to 1.

### 6.2.9 LONG TERM STORAGE

Concrete block permeable pavements reduce the volume of rainfall that flows out from them significantly and the time it takes for the water to flow out is much longer than for conventional drainage systems. Studies reported in CIRIA report C 582 (CIRIA, 2001) have shown that some 11% to 45% of rainfall flows out from the pavement during a rainfall event. Subsequently over the 2 to 4 days after an event, more water flows out to give a total outfall of between 55% and 100%. Thus the permeable pavement should achieve the aims of long term storage, as it will reduce the volume of runoff at critical periods. For most relatively small schemes the

permeable pavement should not require any specific long term storage provision, especially if it is not collecting runoff from impermeable areas. This should be agreed with the regulators during design.

For larger schemes where the pavement is taking areas of impermeable runoff at a 2:1 ratio then specific provision of long term storage may be required. In this case The SUDS Manual provides guidance on the amount of long term storage that is required on any site.

#### 6.2.10 USE OF DRAINAGE ANALYSIS AND DESIGN SOFTWARE

Drainage design software can be used to design drainage systems that include concrete block permeable pavements. This allows the performance of the whole drainage system and the impact of the permeable pavement to be modelled and tested to satisfy all the required design criteria. Software packages usually include a number of different ways of modelling rainfall and runoff but the most common method is that based on the '*Wallingford Procedure*'. The simplest approach is to consider the permeable pavement as an infiltration or storage device, taking into account the following factors:

- Storage volume in the permeable sub-base
- Rate of infiltration or restricted outflow rate.

The rate of infiltration can be determined using the approach described in CIRIA Report 156 (CIRIA, 1996). For larger sites, those that are terraced or ones that are very flat, the use of modelling software is recommended to ensure that the whole system will operate as anticipated and that use of the available storage is optimised.

Another approach is to consider the permeable pavement as a sub-catchment that provides a hydrograph to be applied to the network model. Simple bulk mass balance and simplified flow equations can be used to model the movement of water into and out off the permeable sub-base. Other factors that can be taken into account include:

- Evaporation
- Initial runoff losses
- Runoff routing.

#### 6.2.11 CONVEYANCE OF WATER TO OUTFALL

In a system C attenuation design the water will need to flow horizontally through the permeable sub-base towards an outfall. In many designs the permeable sub-base will be present as discrete areas below the permeable paving, separated by impermeable construction. Careful consideration is required of water flows between different areas of permeable sub-base to ensure that it is held in storage in the correct area and can flow to the outfall where necessary.



Water can be moved between areas using pipes, geocellular boxes or a layer of coarse graded aggregate. Water can also flow along areas of permeable sub-base. There should be sufficient capacity in pipes, boxes or sub-base to convey the water to the outlet(s). On sites that are level it is usually possible to use a limited number of flow controls to ensure that the use of storage in the each area of sub-base is optimised. In this case the main consideration is ensuring that all conduits for water flow (pipes, sub-base, etc) have sufficient flow capacity to drain the area without causing a restriction that would increase the volume of water being stored. On sloping sites a greater number of flow controls are usually required to hold water in the appropriate storage area.

#### 6.2.12 STORAGE DESIGN EXAMPLE

A comprehensive design example can be found in Appendix 1.

### 6.3 STRUCTURAL DESIGN

One of the positive features of a permeable pavement is that the materials used below the surface course to detain or channel water are the very same materials which impart strength to the pavement and thereby allow permeable pavements to sustain traffic loads. Many designers integrate the hydraulic and structural design in order to achieve a pavement where all of its components are contributing to its twin hydraulic and structural purposes.

In this section, Interpave's structural design method is described and the thicknesses and properties of all of the materials within the structure of the pavement can be selected and specified. It differs from the structural design method found in The SUDS Manual, which was based on the previous Edition 4 of this guide, and has been developed to be more user-friendly. So, the following guidance represents the latest structural design method for permeable pavements, superseding previous methods. This section also forms the basis of BS 7533-13:2009, *Guide for the design of permeable pavements constructed with concrete paving blocks and flags, natural stone slabs and setts and clay pavers* – which caters for structural design only.

Typical components of a concrete block permeable pavement are:

#### PAVING BLOCKS

The surfacing comprises concrete blocks manufactured for permeable pavements. They permit water to enter the pavement from its surface either by the use of oversize spacers or by special shapes which create a space between neighbouring blocks.

#### LAYING COURSE MATERIAL

Paving blocks are installed over a laying course material comprising material mostly passing a 6.3mm sieve and mostly retained on a 3mm sieve.

#### DENSE BITUMEN MACADAM BASE

If the permeable pavement is to be trafficked during the construction phase, a DBM course may be installed with holes punched through on a 750mm orthogonal grid. This prevents the contamination of

the pavement materials, although other methods can also be used to achieve this: see Section 6.3.5.

#### PERMEABLE SUB-BASE

The main structural and hydraulic functional layer comprises coarse graded aggregate (CGA) with particles within the range 20mm to 5mm. In the case of more heavily trafficked permeable pavements, a course of hydraulically bound coarse graded aggregate is included, in addition to, or in place of the CGA, to strengthen and stiffen the pavement.

#### CAPPING

In the case of System C pavements, i.e. those in which the water is detained within the pavement, capping material is included below the Impermeable Membrane in order to achieve a firm working platform so that the overlying layers can be correctly installed. It must also act to protect the impermeable membrane from damage and puncturing and it may be necessary to blind the surface of the subgrade. The two recommended capping materials are either 6F1 (finer material) or 6F2 (Coarser Material) as defined in Table 6/1 of Highways Agency's '*Specification for Highway Works – Series 600 – Earthworks*'. In the case of 6F2 materials, it may be necessary to blind the surface with fine material to protect the overlying Impermeable Membrane.

#### IMPERMEABLE MEMBRANE

System C pavements include an Impermeable Membrane which contains all of the water entering the pavement and being detained within it.

#### GEOTEXTILE

Geotextiles may be introduced within the pavement: see Section 7.8.

### 6.3.1 THE STRUCTURAL DESIGN PROCESS

The structural design process comprises four stages:

#### **Stage 1**

Use Table 7 to select the Category of Loading, from 1 to 6.

#### **Stage 2**

Use the Design Chart shown as Figure 23 in the case of Systems A & B permeable pavements and as Figure 24 in the case of System C pavements, to determine the pavement course thicknesses.

#### **Stage 3**

Adjust the thicknesses from the Design Chart for pavements installed over subgrades of CBR less than 5% using Table 8. Note that in the case of System C (detention) pavements, the Equilibrium Suction Index CBR value is used and in the case of System A and System B infiltration pavements, the soaked CBR is used, using the soaking procedure described in Section 7 of BS1377:1990:Part 4.

## 6.3.2 STAGE 1 – SELECTION OF LOADING CATEGORY

**Stage 4**

Consider the need for site access. Permeable pavement construction materials must be kept clean during the construction phase. This can be inconvenient when the construction method requires that the roads be installed early and can be used for site access. Various methods can be used to resolve this issue: see Section 6.3.5.

Refer to Section 7 for specification clauses for the materials within the permeable pavement.

Table 7 shows pavements of different types and the Category of Loading in which they fall. It also shows the maximum number of standard 8,000kg axles for each Category of Loading based upon the assumption that pavements are designed to achieve a life of 25 years' trafficking. Using knowledge of either the number of standard 8000kg axles or the end use of the pavement, select one of the Categories 1 to 6. Note that there is a significant difference between pavements designed for Load Categories 2 and 3.

1 DOMESTIC PARKING	2 CAR	3 PEDESTRIAN	4 SHOPPING	5 COMMERCIAL	6 HEAVY TRAFFIC
No Large Goods Vehicles	Emergency Large Goods Vehicles only	One Large Goods Vehicle per week	Ten large Goods Vehicles per week	100 Large Goods Vehicles per week	1000 large Goods Vehicles per week
<b>Zero standard axles</b>	<b>100 standard axles</b>	<b>0.015msa</b>	<b>0.15msa</b>	<b>1.5msa</b>	<b>15msa</b>
Patio	Car parking bays and aisles	Town/city pedestrian street	Retail development delivery access route	Industrial premises	Main road
Private drive	Railway station platform	Nursery access	School/college access road	Lightly trafficked public road	Distribution centre
Decorative feature	External car showroom	Parking area to residential development	Office block delivery route	Light industrial development	Bus station (bus every 5 minutes)
Enclosed playground	Sports stadium pedestrian route	Garden centre external display area	Deliveries to small residential development	Mixed retail/ industrial development	Motorway Truck Stop
Footway with zero vehicle overrun	Footway with occasional overrun	Cemetery Crematorium	Garden centre delivery route	Town square	Bus stop
	Private drive/ footway crossover	Motel parking	Fire station yard	Footway with regular overrun	Roundabout
		Airport car park with no bus pickup	Airport car park with bus to terminal	Airport landside roads	Bus lane
		Sports centre	Sports stadium access route/ forecourt		

**Table 7:** Loading categories.

msa = millions of standard 8,000 kg axles.

Pavements sustaining Load Categories 3 to 6 include a hydraulically bound base whereas pavements sustaining Load Categories 1 and 2 require only unbound materials. Therefore, if there is any doubt between 2 and 3, it is safer to select 3.

6.3.3 STAGE 2 – SELECTION OF PAVEMENT COURSE MATERIALS AND THICKNESSES

Use either Figure 23 or Figure 24 to select pavement course thickness and material types according to whether the pavement is System A or B (full or partial infiltration) or System C (detention or tanked). Note that the resulting pavement will be suitable for subgrades of CBR 5%. The CBR should be the lowest value which the subgrade can be expected to reach during the life of the pavement. In the case of System C (detention or tanked) pavements where the water is contained within the pavement, this will normally be the Equilibrium Suction Index CBR and in the case of System A and System B infiltrating pavements, this will be the soaked CBR.

DESIGN CHART SYSTEMS A & B

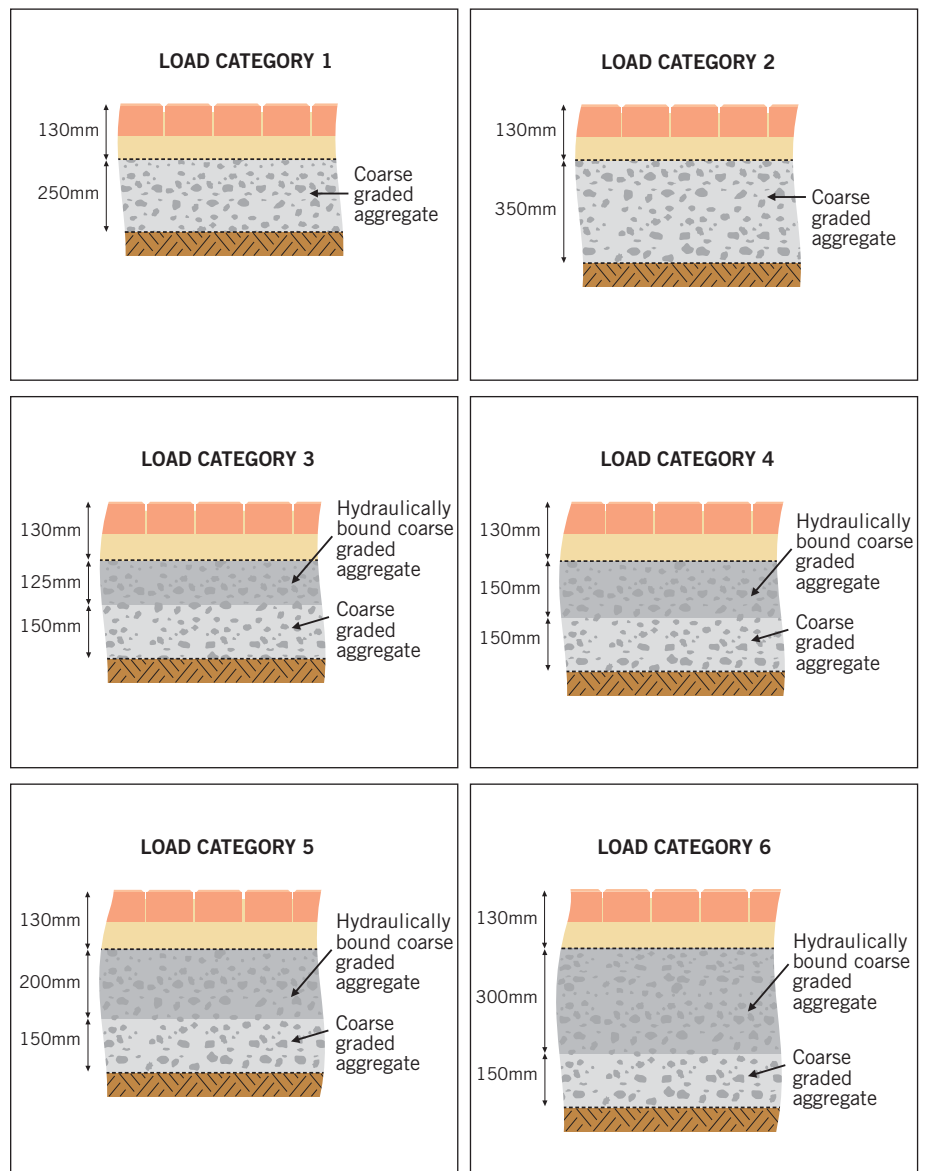
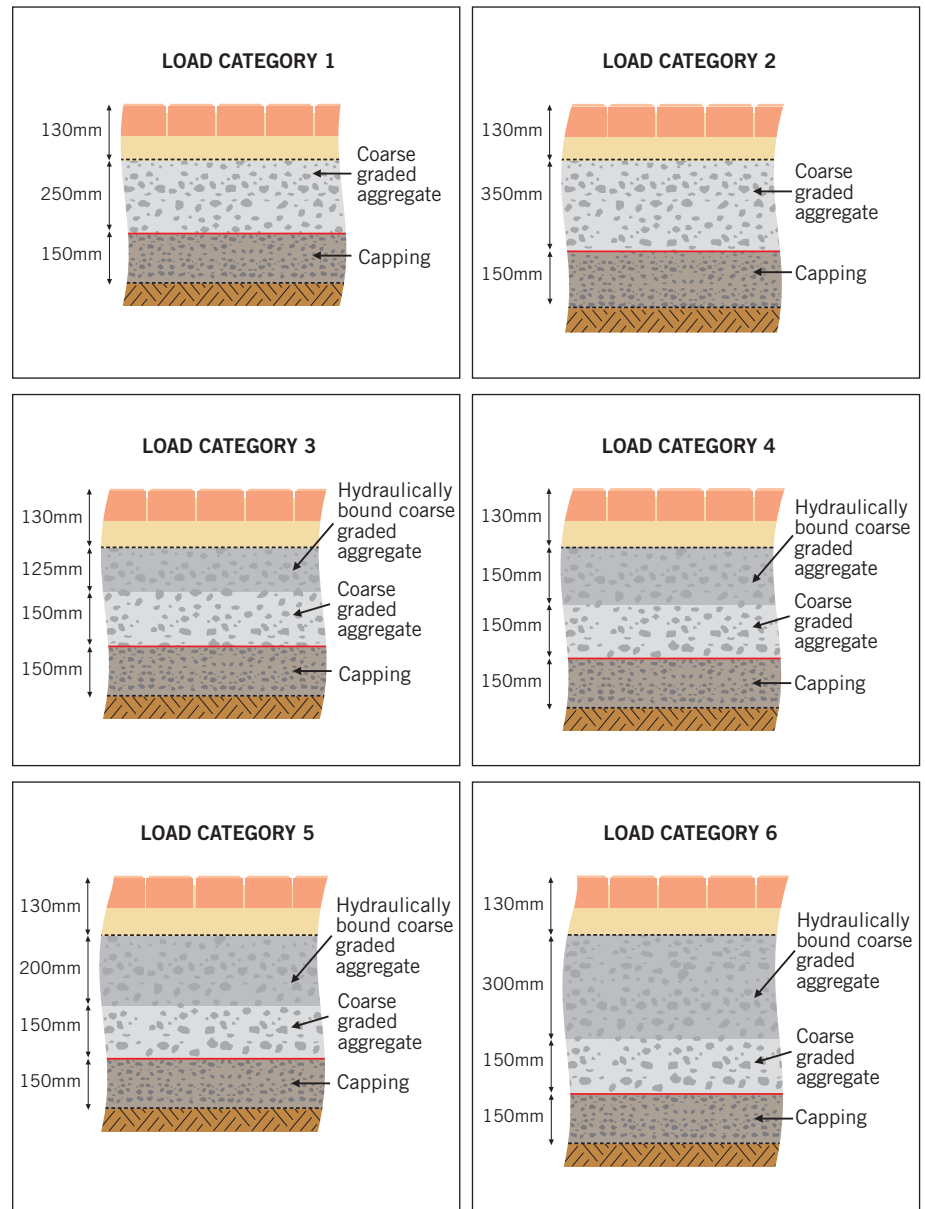

Figure 23: Design chart for Systems A and B (infiltration) permeable pavements (on subgrade  $\geq$  5% soaked CBR).

**Key:**  
 .....  
 Geotextile  
 (upper geotextile optional)

## DESIGN CHART SYSTEM C



**Figure 24:** Design chart for System C (detention) permeable pavements (on subgrade  $\geq 5\%$  equilibrium moisture content CBR).

In the case of detention pavements, Figure 23 shows the location of the Impermeable Membrane. It is important that the Impermeable Membrane is installed above those materials which would deteriorate if they were saturated. This means that the Impermeable Membrane is installed at the interface of the coarse graded aggregate and the capping material. The Impermeable Membrane is brought to just below the surface of the pavement at its perimeter to maximise the detention volume of the pavement.

System A and System B infiltrating pavements do not include an Impermeable Membrane but do include a geotextile material at the interface between the coarse graded aggregate and the subgrade. This layer is not brought to the surface at the perimeter of the pavement.

### 6.3.4 STAGE 3 – ADJUSTMENT TO PAVEMENT DESIGN FOR LOW CBR SUBGRADES

The Design Charts in Figures 23 and 24 apply in the case of subgrade CBR  $\geq 5\%$ . In the case of lower CBR values, an adjustment must be made. For System C pavements, the adjustment will normally comprise either the provision of additional capping material or the provision of the coarse graded aggregate. In the case of System A and System B infiltrating pavements, because of the cascading water, the additional strength is provided by increasing the thickness of unbound coarse graded aggregate – materials including fines ie. capping materials, cannot be used in the presence of water. Note that in many cases, a subgrade CBR of less than 5% is an indication that the material may be too fine to act as an infiltration medium which means Systems A and B cannot be used.

CBR of subgrade	Adjustment to thickness of coarse graded aggregate in the case of System A and System B (infiltrating) pavements (mm) <sup>†</sup>	Total thickness of capping material in the case of System C (detention) pavements (mm)
1%	+300* <sup>^</sup>	600*
2%	+175 <sup>^</sup>	350
3%	+125 <sup>^</sup>	250
4%	+100 <sup>^</sup>	200
5%	Use thicknesses in Design Chart	150
8%		
10%		
15%		

**Table 8:** Low subgrade CBR adjustment.

\* Expert guidance should be sought in the case of pavements constructed over subgrades of CBR less than 2%. <sup>^</sup> Subgrades of CBR less than 5% are often too fine to permit sufficient infiltration.

<sup>†</sup> Note that the additional coarse graded aggregate values in this column can be applied, in the case of System C pavements, instead of the enhanced capping thickness shown in the middle column.

The additional capping thicknesses to be provided in the case of low CBR subgrades can only be determined approximately during the design process because the condition of the subgrade will depend upon site drainage conditions, level(s) of water table(s) and recent weather patterns. The aim is to provide sufficient additional material to ensure that the overlying courses can be compacted successfully. Table 8 shows values which have been found to achieve this but the actual thickness must be determined by site trials undertaken by experienced ground workers.



### 6.3.5 STAGE 4 – PROTECTION FROM CONSTRUCTION TRAFFIC

**This stage should be added if the permeable pavement is required to sustain site construction traffic.** Often there is a need to use roads and hardstanding areas as temporary routes during construction. Obviously, this would quickly block the open graded permeable sub-base with mud. There are several solutions to this issue including:

- For System C, construct a normal capping layer and use this as the temporary road surface. Construct the permeable pavement over it towards the end of construction.
- Construct the permeable sub-base and then cover it with a sacrificial layer of geotextile and hardcore (100mm thick). Use this as the temporary road surface. Towards the end of construction remove the sacrificial layer and construct the laying course and blocks.
- Consider the construction process during design and identify areas and routes for construction traffic and others that are prohibited. Use conventional construction in the former and permeable paving in the latter.
- Construct the permeable sub-base and then cover it with an impermeable layer of Dense Bitumen Macadam (DBM). Use this as the temporary road surface.

### 6.3.6 DENSE BITUMEN MACADAM

The Dense Bitumen Macadam (DBM) material should be installed in accordance with BS4987-2:2003 '*Coated macadam (asphalt concrete) for roads and other paved areas – Part 2: Specification for transport, laying and compaction.*' Experience has demonstrated that a tracked asphalt paving machine is easier to manoeuvre over 'unbound' permeable sub-base material than a wheeled paving machine.

Coring or punching a pattern of 75mm diameter holes through this material on an orthogonal grid of 750mm, just prior to installing the permeable block layer, thus converting the pavement to a permeable pavement. The DBM course remains in-situ throughout the service life of the pavement. For load categories 3, 4, 5 and 6 the DBM layer can substitute some or all the hydraulically bound coarse graded aggregate course layer but the minimum thickness of the remaining hydraulically bound coarse graded aggregate course layer must not be less than 125mm. As the DBM has no water storage capability it will be necessary to check that the remaining permeable layer has sufficient water storage capacity.

For load categories 1 and 2 the DBM is in addition to the unbound coarse graded aggregate.

The thickness of the DBM depends upon the number of standard 8,000kg axles which will be applied by site traffic and by in-service traffic. In the case of site traffic, the following values can be used. They are taken from Figure 2 of BS7533-1:2001 '*Pavements constructed with clay, natural stone or concrete pavers – Part 1: Guide for the structural design of heavy duty pavements constructed of clay pavers or precast concrete paving blocks*':

<b>Up to 20 dwellings:</b>	<b>200 standard axles</b>
<b>Up to 50 dwellings or 5,000m<sup>2</sup> commercial development:</b>	<b>500 standard axles</b>
<b>Up to 80 dwellings or 8,000m<sup>2</sup> commercial development:</b>	<b>1000 standard axles</b>
<b>Large development</b>	<b>5000 standard axles</b>

Add to the above the in-service traffic as shown in Table 10. For example, if the site is for an 8,000m<sup>2</sup> commercial development and is Load Category 3 from Table 7, then the total number of standard axles for which the DMB course is designed is 1,000 + 15,000 = 16,000.

The thickness of the DBM required is taken from Figure 3 of BS7533-1:2001 '*Pavements constructed with clay, natural stone or concrete pavers – Part 1: Guide for the structural design of heavy duty pavements constructed of clay pavers or precast concrete paving blocks*' and is shown in Table 9.

<b>Total Traffic (Site plus in-service) (Cumulative Standard Axles (msa))</b>	<b>Thickness of Dense Bitumen Macadam (mm)</b>
Up to 1.5	130
1.5 to 4.0	145
4.0 to 8.0	170
8.0 to 12.0	185

**Table 9:** Thickness of Dense Bitumen Macadam for permeable pavements to be used by site traffic.

## 7. SPECIFICATION AND MATERIALS

### 7.1 PAVING BLOCKS

The surfacing shall comprise paving blocks manufactured by a member of Interpave, in accordance with BSEN1338:2003 – ‘Concrete paving blocks – Requirements and test methods’ BSI 2003. They shall be manufactured and marketed for permeable pavements. Originally blocks 80mm thick were used for all types concrete block permeable pavements but thinner concrete blocks are now available that are suitable for specific loadings and applications. It is recommended that advice from the block paving manufacturer is sought on suitable block thicknesses for particular applications.

### 7.2 LAYING COURSE AND JOINTING MATERIAL

The laying course material must be sufficiently coarse to allow the free vertical flow of water and to prevent its intrusion into the underlying coarse graded aggregate, yet sufficiently fine to permit the accurate installation of the paving blocks. Typically, the laying course and jointing material should fall within the Particle Size Distribution envelope of Table 11, but advice should be sought from the block paving manufacturer on specific gradings suitable for their products/systems. The material should comply with the requirements of a material of type 2/6.3 Gc 80/20 according to BS EN 13242:2002. ‘Aggregates for unbound and hydraulically bound materials for use in civil engineering works and road construction’ as shown in Table 11. Note that the term 2/6.3 means that the material has particle sizes that are predominantly within the range of 2mm to 6.3mm. This is the way in which aggregates, including fine aggregates, are designated in BS EN 13242:2002 which states: “This designation accepts the presence of some particles which are retained on the upper sieve (oversize) and some which pass the lower sieve (undersize)”, i.e. there is a small proportion of material that is greater than 6.3mm and less than 2mm.

BS Sieve size (mm)	Percentage Passing (%)
14	100
10	98-100
6.3	80-99
2.0	0-20
1.0	0-5

**Table 10:** Typical Particle Size Distribution limits for laying course material.

### 7.2.1 JOINTING AND VOIDS MATERIAL

Typically, materials are similar to those for the laying course. Advice should be sought from the paving block manufacturer on the exact material type that is suitable for each block system.

## 7.3 COARSE GRADED AGGREGATE (CGA)

Typically the coarse graded aggregate (CGA) material should fall within the Particle Size Distribution envelope of Table 11 but advice should be sought from the block paving manufacturer on specific gradings suitable for their product/systems. CGA should comply with the requirements of BS EN 13242:2002 – ‘*Aggregates for unbound and hydraulically bound materials for use in civil engineering work and road construction.*’ The material should be designated Type 4/20 (4mm minimum and 20mm maximum particle size). Details on the availability and suitability of these materials should be obtained from local aggregate suppliers.

In order to be able to sustain the effects of traffic under both dry and wet conditions, the CGA should meet the physical requirements shown in Table 12.

The material must have sufficient internal stability to perform both during installation and in the long term. In general hard crushed rock aggregates will perform well, whereas both crushed and naturally occurring rounded gravels may be unstable – possibly in service and very likely during installation. If a material remains stable during installation, it is very likely that it will remain stable once the pavement is complete.

**Table 11:** Typical Particle Size Distribution limits for Type 4/20 coarse graded aggregate.

Sieve size (mm)	Percentage Passing (%)
40	100
31.5	98-100
20	90-99
10	25-70
4	0-15
2	0-5

### 7.3.1 LAYING COURSE AND SUB-BASE GRADING COMPACTIBILITY

Where a geotextile is not used between the laying course and sub-base, the two layers must meet conventional soil filter laying course criteria to prevent migration of the finer laying course into the sub-base.

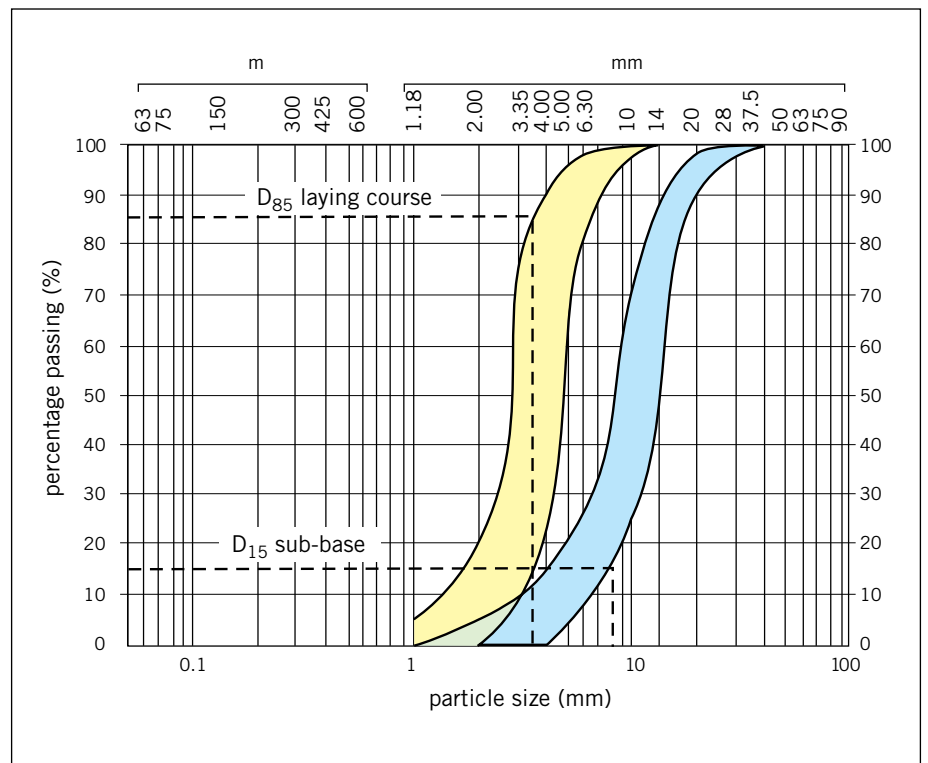

**Figure 25:** Grading compatibility curve.

The aggregates should meet the following criteria:

$$\frac{D_{15} \text{ sub-base}}{D_{85} \text{ laying course}} \leq 5$$

The example shown in Figure 25 gives

$$D_{15} \text{ sub-base} = 8.0\text{mm} \quad \text{and} \quad D_{85} \text{ laying course} = 3.7\text{mm}$$

$$\frac{8.0\text{mm}}{3.7\text{mm}} = 2.16 \leq 5, \text{ therefore OK}$$

It is advisable to check visually that the laying course particles fit into the voids of the sub-base material without excessive migration into the sub-base.

Where  $D_x$  is the particle size at which  $x$  percent of the particles are finer. For example  $D_{15}$  is the particle size of an aggregate for which 15% of the particles are smaller than  $D$  and 85% are coarser. On the grading curve in Figure 25, 15% are smaller than so  $D_{15} = 9\text{mm}$ .

A material meeting the average of the laying course and sub-base grading limits recommended in this guide should meet these requirements. However, a check should always be made on the actual materials proposed for use on a site to make sure they are compatible with each other.

Properties	Category to BS EN 13242 or BS 12620
Grading	4/20 (preferred) or 4/40, Gc 85 – 15, GTC 20/17.5
Fines content	$f_4$
Shape	$FI_{20}$
Resistance to fragmentation	$LA_{30}^*$
Durability: Water absorption to BS EN 1097-6:2000, Clause 7 – for $WA > 2\%$ , magnesium sulphate soundness	$WA_{24}^2$  $MS_{18}$
Resistance to wear	$M_{DE}^{20}$
Acid-soluble sulphate content: – aggregates other than air- cooled blast-furnace slag air-cooled blast-furnace slag	$AS_{0.2}$ $AS_{1.0}$
Total sulphur: – aggregates other than air-cooled blast-furnace slag air-cooled blast-furnace slag	$\leq 1\%$ by mass $\leq 2\%$ by mass
Volume stability of blast- furnace and steel slags: air-cooled blast-furnace slag – steel slag	Free from dicalcium silicate and iron disintegration in accordance with BS EN 13242:2002, 6.4.2.2 $V_5$
Leaching of contaminants	Blast-furnace slag and other recycled materials should meet the requirements of the Environment Agency 'Waste Acceptance Criteria' for inert waste when tested in accordance with BS EN 12457-3

**Table 12:** Physical property requirements for CGA.

\*The durability of materials will depend on the nature of the source.  
In some instances a lower value of LA may need to be specified based on local experience.

Blast furnace slags have been used successfully as CGA. Blast furnace slag should comply with BS13242:2002. Leaching tests should be carried out in accordance with BSEN12457-3 and the results should meet the requirements of Environment Agency's 'Waste Acceptance Criteria' for inert waste.



#### 7.4 HYDRAULICALLY BOUND COARSE GRADED AGGREGATE

In the case of more heavily trafficked permeable pavements, a course of Hydraulically Bound coarse graded aggregate is included to strengthen and stiffen the pavement.

The material shall be manufactured using aggregate of Particle Size Distribution within the envelope of Table 11 and shall comply with one of the following:

##### CEMENT BOUND MIXTURES

BS EN 14227-1:2004. *'Hydraulically bound mixtures – Specifications – Part 1: Cement bound granular mixtures.'*

Minimum cement content by mass = 3%.

Strength Class = C<sub>5/6</sub> (As defined in Table 2 of BS EN 14227-1:2004.)

Minimum permeability 20,000mm/hour.

The 28 days Elastic Modulus would be expected to be approximately 10,000N/mm<sup>2</sup> but this is not a specification requirement.

#### 7.5 DENSE BITUMEN MACADAM (DBM)

The DBM should be a 0/32mm size dense base as defined in Section 5.2 of BS4987-1:2005 *'Coated macadam (asphalt concrete) for roads and other paved areas – Part 1: Specification for constituent materials and for mixtures.'* Normally, the material should be a DBM 50 according to Clause 4.7 of BS4987-1:2005. Note that this means that the material should be designed in accordance with clause 929 of the *'Specification for Highway Works: 2003'* (Highways Agency). After completion of the DBM punching operation and prior to commencing construction of the concrete block paving layer, all debris shall be removed and the holes in the DBM shall be filled with coarse graded aggregate.

#### 7.6 CAPPING

Capping material is included in order to achieve a firm working platform so that the overlying layers can be correctly installed. Capping materials normally comprise low cost locally available materials capable of achieving a CBR of 15%. All capping materials should meet the requirements of either 6F1 or 6F2 of Table 6.1 of Highways Agency's *'Specification for Highway Works – Series 600 – Earthworks'*. Crushed concrete, hardcore and quarry scalplings are commonly used as capping materials.

#### 7.7 IMPERMEABLE MEMBRANE

System C (detention or tanked) pavements include an Impermeable Membrane which contains all of the water entering the pavement and being detained within it.

There are three categories of Impermeable Membrane as follows:

#### **IMPERMEABLE MEMBRANE CATEGORY 1**

Where the consequences of localised failure of the Impermeable Membrane are minor, 2000 gauge polythene can be used with overlapping joints.

#### **IMPERMEABLE MEMBRANE CATEGORY 2**

Where it is important that there is no escape of water (where, for example, contamination would be unacceptable), a more durable material should be specified: seek specialist advice.

#### **IMPERMEABLE MEMBRANE CATEGORY 3**

In the case of Impermeable Membranes installed over occupied buildings (including car parks), seek specialist advice.

## 7.8 GEOTEXTILES

Geotextiles may be used in two locations within concrete block permeable pavements:

- An optional Upper Geotextile at the laying course/coarse graded aggregate interface may be included according to the paving block manufacturer's recommendations.
- Between the laying course and the permeable sub-base.

A report prepared by The Environmental Protection Group Limited (EPG) on the efficacy of geotextiles used in permeable pavements is available to download from [www.paving.org.uk](http://www.paving.org.uk)

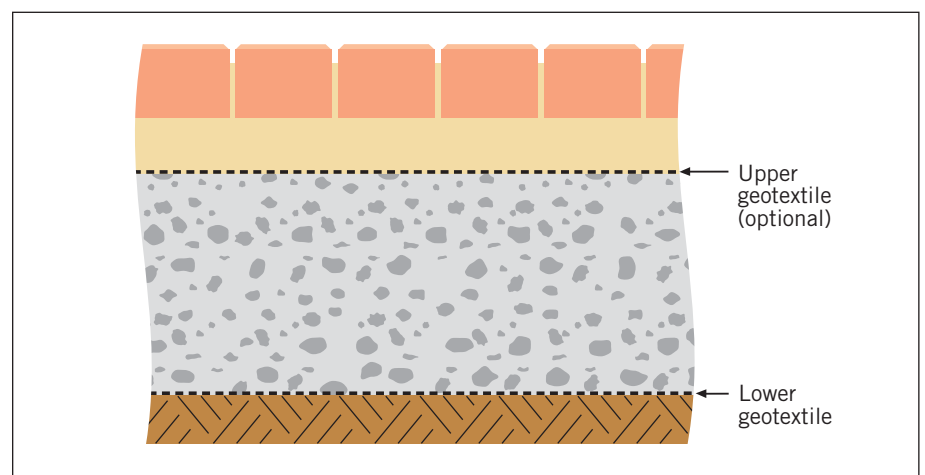

**Figure 26:** Locations of geotextiles.

### 7.8.1 CHARACTERISTICS

The geotextile should function as a filter and must be installed according to the manufacturer's requirements, and should be submitted for approval by the engineer. The geotextile can be either a monofilament woven, non woven firmly bonded or needle punched non-woven fabric. The geotextile should be manufactured

from a suitable polyethylene or polypropylene filament able to withstand naturally occurring chemical and microbial effects.

#### 7.8.2 QUALITY

The tensile properties of the material should be verified in accordance with EN ISO 10319 by both internal quality assurance and external quality control and assurance by an independent authorised laboratory. The production of the geotextile shall be EN ISO 9001 certified. Each roll shall have at least one identification label with roll number and product type in accordance with EN ISO 10320, and carry a CE mark.

#### 7.8.3 INSTALLATION PROCEDURE

Adjacent rolls of the geotextile should be overlapped by at least 300mm. All vehicles should be prevented from trafficking directly over the material. The material should be protected from ultra-violet light.

## 8. DETAILING

This section considers a selection of details for a range of typical situations to illustrate the basic principles involved.

### 8.1 EDGE RESTRAINTS

As with conventional concrete block pavements, the provision of adequate edge restraints is vital to the successful performance of a concrete block permeable pavement.

If suitable edge restraint is not provided the blocks can rotate, joints can spread and loss of laying course material can cause surface settlement. The form of restraint normally used is a precast concrete kerb or edging placed in a concrete haunch. Further advice on these aspects is available via the Interpave website.

### 8.2 OUTLETS AND CONVEYANCE

System B and C pavements require an outfall from the permeable sub-base to allow the water to drain. There are various ways of collecting the water from the permeable sub-base.

The most effective way of connecting the permeable sub-base to the drainage system in Systems B and C is to use fin drains or perforated pipes. However, perforated pipes need sufficient cover to carry vehicle loads and may need to be installed in a trench below the permeable sub-base to achieve this.

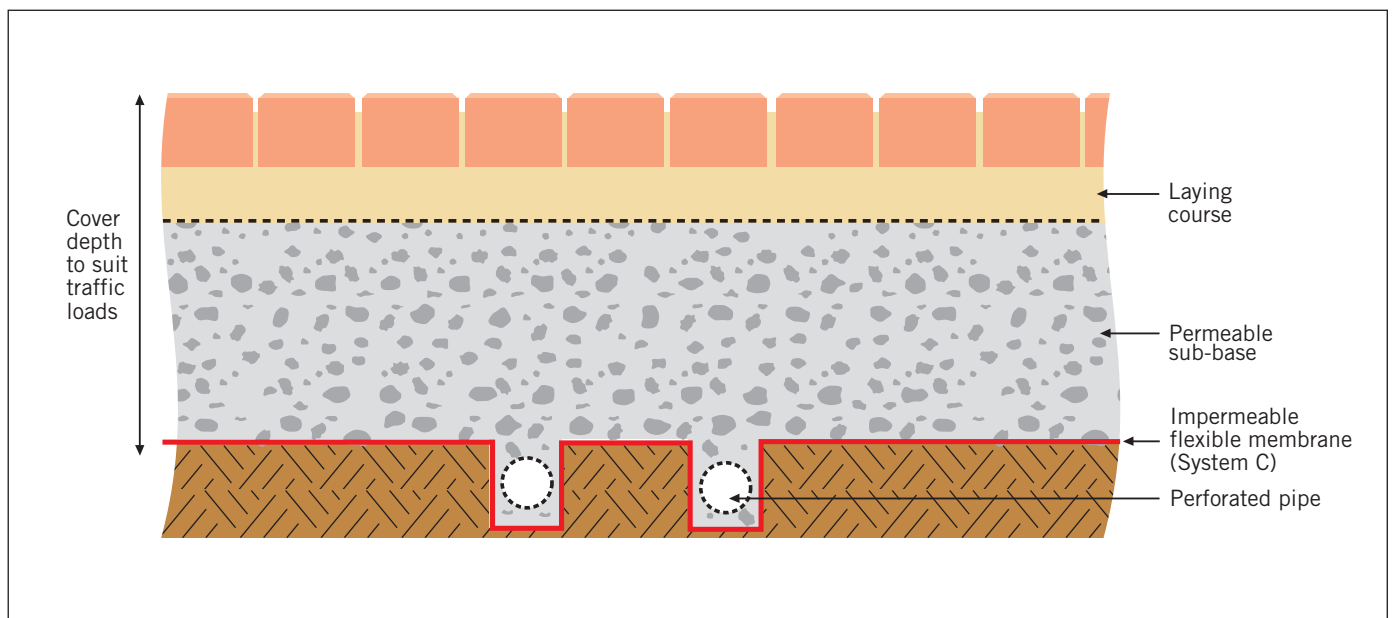

**Figure 27:** For large areas of permeable paving perforated collector pipes in trenches can be used to collect the water.

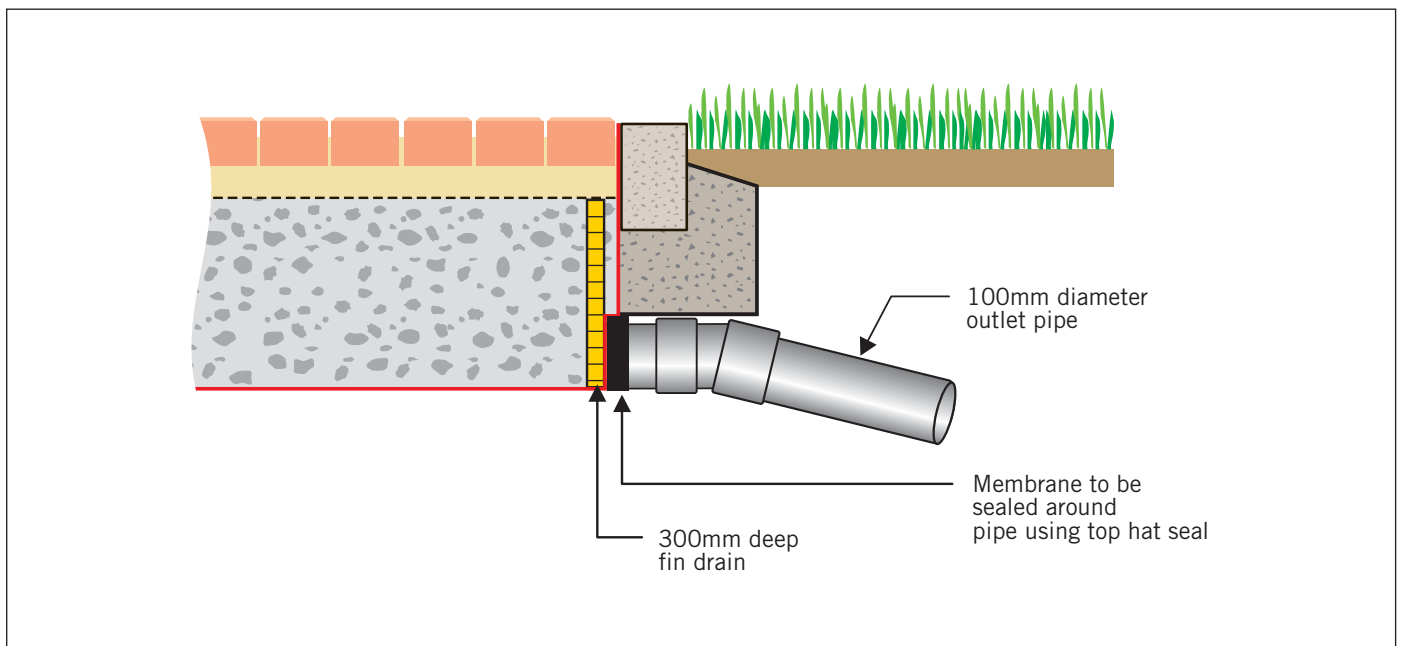

**Figure 28:** Collection of water by fin drains.

## 8.2.1 SPACING OF OUTFLOW PIPES

The drainage capacity of the permeable sub-base material and the spacing of outlet pipes in trenches for System C can be assessed using guidance provided by Cedergren (1974). The maximum surface runoff rate that can be removed by a flat permeable sub-base is estimated by:

$$Q = k (h/b)^2$$

Where:

Q = runoff rate into pavement (m/s)

k = coefficient of permeability of permeable sub-base (m/s)

h = thickness of permeable sub-base above impermeable base (m)

b = half the distance between drains (m)

For sloping subgrades and non-symmetrical pipe layouts, the flow in the permeable sub-base can be estimated using Darcy's Law:

$$Q = Aki$$

Where:

Q = flow capacity of permeable sub-base (m<sup>3</sup>/s)

A = cross sectional flow area (m<sup>2</sup>)

k = coefficient of permeability of permeable sub-base (m/s)

i = hydraulic gradient (assumed to be the slope of the subgrade – generally a conservative assumption).

The spacing of the outlets (pipes or fin drains) on many sites is usually governed by the site layout and the locations of the permeable pavement. The maximum spacing is only an issue on larger areas of paving. Where individual outlet pipes are provided at discrete locations (rather than a series of perforated collector pipes) the number of outlets should be designed to provide sufficient drainage to the permeable sub-base (Figure 29).

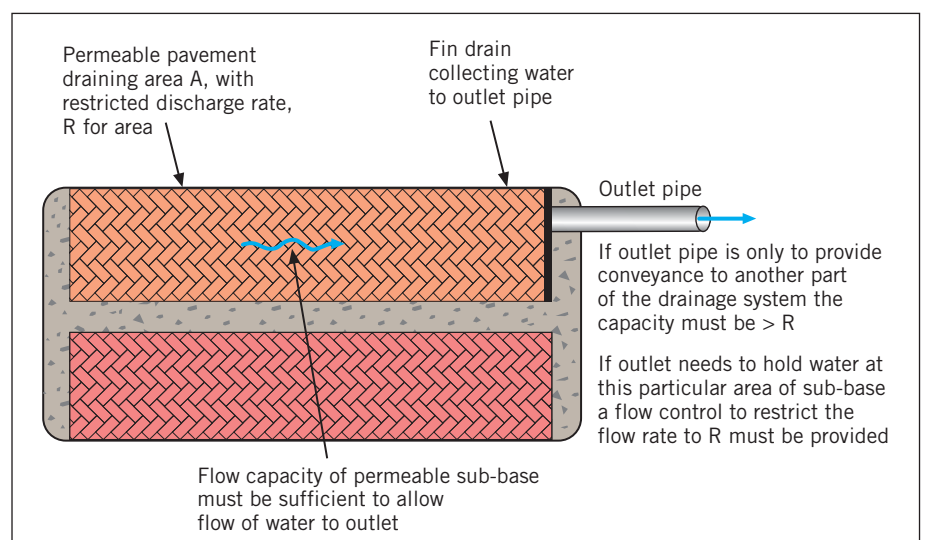

**Figure 29:** Permeable sub-base drainage principles.



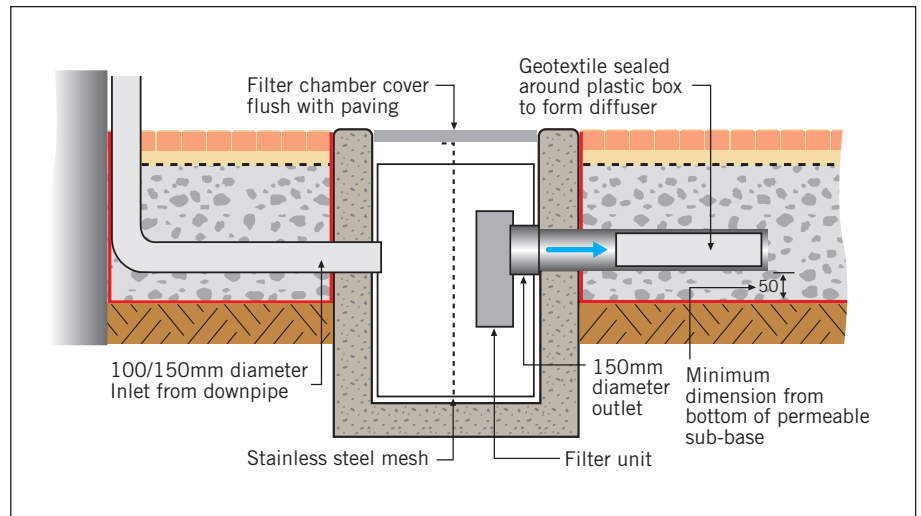

Figure 30: Typical roof drainage outlet.

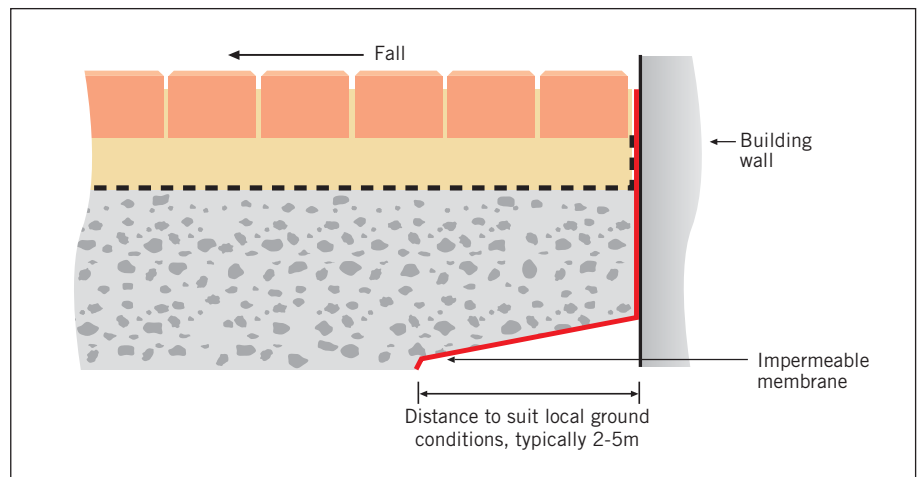

Figure 31: Typical abutment to building.

### 8.3 INLETS FROM ROOF DRAINAGE

A typical arrangement of draining roof water into the pavement is shown in figure 30. The water discharged from the downpipe should be conveyed and disbursed away from the building so not to scour the jointing material between the blocks. This can be achieved by using concrete paving flags in the location of the roof water discharge. This method is preferred to systems that connect directly into the sub-base because no maintenance of manhole connections/filters is necessary. An impermeable membrane below the permeable sub-base can be used to prevent water infiltration close to the foundations. This would typically extend for 2m to 5m depending on the ground conditions and the risk of water adversely affecting the foundations. A typical detail is shown in Figure 31.

Syphonic roof drainage can also be connected to permeable pavements. However, this type of roof drainage directs large volumes of water into the pavement very quickly which results in very high flow velocities. Therefore inlet diffusers that connect the syphonic drainage into the permeable sub-base should be designed to allow the water into the pavement without affecting the flow rate. It is best to recommend that the manifold is designed by the syphonic drainage design consultant.

## 8.4 SLOPING SITES

Constructing permeable pavements on sloping sites is often unavoidable and, without precautions, the water in the permeable sub-base will simply run to and collect at the lowest point, and the available storage will be reduced, see Section 6.2.7. The maximum gradient of the pavement surface should be about 5% (1 in 20)

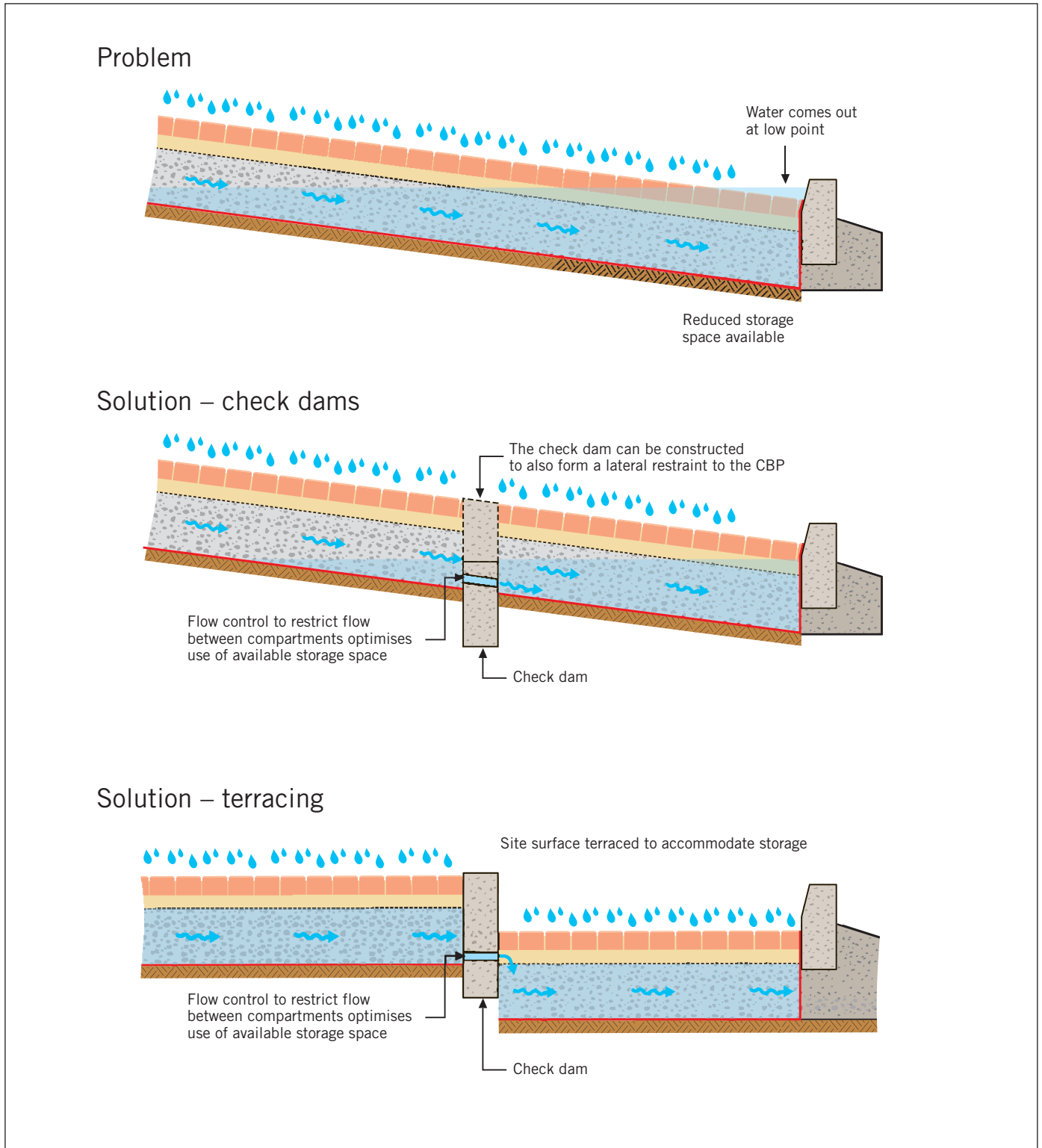

**Figure 32:** Solutions to permeable pavements on sloping sites.

for all types to prevent water flowing over the surface and not entering the permeable sub-base. There are four potential solutions to this issue:

- Install dams within the permeable sub-base with flow controls to ensure the water does not flow to the lowest level and come out of the surface. There are various ways of achieving this including bunds formed in concrete, membranes or blockwork (Figure 32).
- Terrace the site to give flat areas of permeable paving that have separated permeable sub-base storage areas.
- Use high capacity geocellular storage (plastic boxes) at the lower end of the site to increase storage capacity.
- The permeable sub-base thickness can be increased to allow for the reduced storage capacity in the permeable sub-base at the top of the slope.

These precautions are required wherever the permeable sub-base is used for water storage on sloping sites (including any infiltration systems – i.e. Systems A or B). In all cases careful analysis and detailing is required to ensure that the water flows within the pavement are as predicted and that unexpected ‘spring lines’ do not occur in the pavement. The exact design will depend on the site area, discharge limits, etc.

## 8.5 LANDSCAPING

Landscaping should be designed so that it does not cause soil and mulch to be washed onto the permeable pavement and cause clogging. Detailing of the landscape edge is especially important and a typical arrangement is shown in Figure 33.

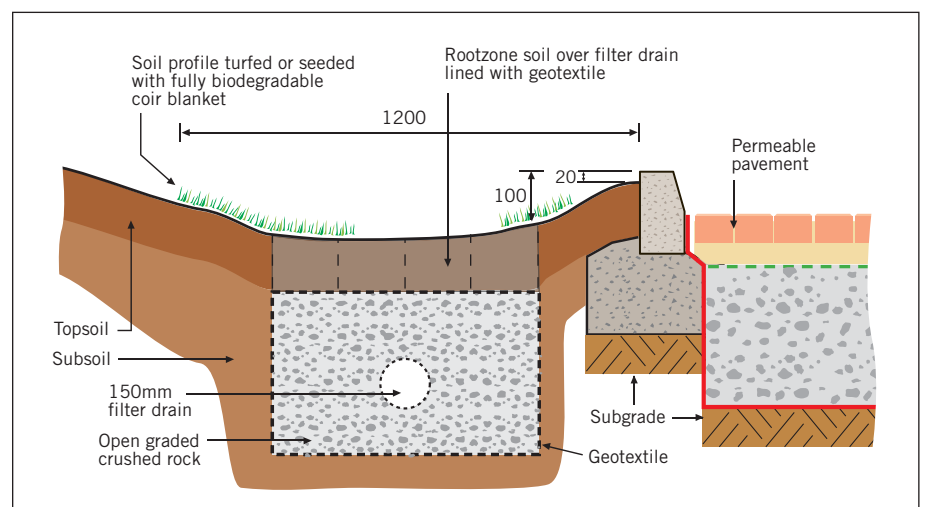

Figure 33: Typical perimeter detail.

## 8.6 SERVICE CORRIDORS

See Section 5.4 for information and details related to handling service runs.

## 9. CONSTRUCTION

### 9.1 SITE PRECAUTIONS

Preventing and diverting impermeable contaminants such as soil and mud from entering the base and pavement surface both during and after construction are imperative to ensure that the pavement remains permeable throughout its design life. Simple practices such as keeping muddy construction equipment well away from the area, installing silt fences, staged excavation and temporary drainage swales which divert runoff away from the area should be considered. For other techniques to protect the pavement during construction while allowing site access, see Section 6.3.5.

### 9.2 CONCRETE BLOCK PAVING

Generally, the concrete block layer should be constructed in accordance with BS 7533 : Part 3: 2005, '*Code of practice for laying precast concrete paving blocks and clay pavers for flexible pavements.*' In accordance with good practice, it is advisable that, at the cessation of every workday, the block surface layer is fully compacted and jointed to within 1m of the laying face. Additional information can be downloaded from the Interpave website [www.paving.org.uk](http://www.paving.org.uk).

Where appropriate, additional specific information for the construction of a permeable pavement should be sought from the concrete block manufacturer. Advice should also be sought from them for product-specific requirements on laying and jointing materials, block patterns and block laying procedures.



**Figure 34:** Machine laying of concrete paving blocks offers a particularly efficient solution for permeable as well as conventional block pavements.



### 9.3 JOINT SEALING

If required, joint sealants specifically designed to bond the jointing material but also to allow infiltration of all the surface water are available and only these types of sealants should be used on permeable pavements. Advice should always be sought from the sealant manufacturer on the appropriate type and method used. Never use conventional block pavement sealants.

### 9.4 LAYING COURSE AND JOINT FILLING

The construction of the laying course is as for conventional block paving, in accordance with BS 7533 Part 3, but using a 50mm thickness. Similarly, brushing in of the jointing material should also comply with that standard: it is essential that joints are fully filled.

### 9.5 PROTECTION FROM CONSTRUCTION TRAFFIC

Refer to Section 6.3.5 for alternative methods, which include use of a Dense Bitumen Macadam (DBM) course as follows.

Construct the permeable sub-base and then cover it with an impermeable layer of DBM, see Table 10 for DBM layer thicknesses. Use this as the temporary road surface. The DBM material should be installed in accordance with BS4987-2:2003 '*Coated macadam (asphalt concrete) for roads and other paved areas – Part 2: Specification for transport, laying and compaction.*' Experience has demonstrated that a tracked asphalt paving machine is easier to manoeuvre over 'unbound' permeable sub-base material than a wheeled paving machine. Towards the end of construction form holes in the asphalt and fill the holes with the 2/6.3 laying course material. Construct the laying course and blocks over the asphalt. Typically, holes should be 75mm diameter on an orthogonal grid of 750mm.



**Figure 35:** Tracked asphalt paving machine installing DBM over a permeable sub-base.

## 9.6 GEOTEXTILE

Any geotextile required between layers should be installed in accordance with the manufacturer's instructions and with overlaps between adjacent strips a minimum of 300mm wide, without any folds or creases. It is recommended that specialist advice be sought from the manufacturer or supplier of the geotextile.

## 9.7 PERMEABLE SUB-BASE

As permeable sub-base materials lack fines, there is potential for segregation during the transportation and construction process. Care should be taken to avoid segregation but, if this occurs, remedial, corrective action must be taken. This can be minimised by using an angular, crushed material with high surface friction.

The nature and grading of the permeable sub-base will vary between different sources and it is often best to undertake site trials to determine the appropriate construction methodology.



**Figure 36:** Typical 4/20 coarse graded aggregate sub-base material.

The permeable sub-base should be laid in 100 – 150mm layers and compacted to ensure that the maximum density is achieved for the particular material type and grading, without crushing the individual particles, or reducing the void ratio below the design value, within a tolerance of +20mm to – 15mm of the design. The materials are relatively self compacting and heavy compaction is not usually required. Recycled material can be used where a source is conveniently available but care should be taken that this is of consistent quality, has an appropriate grading and is free of unacceptable materials such as organic matter or steel scrap.



### **9.8 IMPERMEABLE MEMBRANE**

For System C – no infiltration – the impermeable membrane must be correctly specified, installed and treated with care to ensure that it is not damaged during construction.

### **9.9 PREPARATION OF SUBGRADE**

Any soft spots should be excavated first and back-filled with suitable well-compacted material. The subgrade, or original ground formation, should be prepared by trimming to level and compacting, in accordance with the '*Specification for Highway Works*', to a tolerance within +20mm to -30mm. If subgrade improvement is employed, testing will be needed to demonstrate that the design CBR values have been consistently achieved.

## 10. PERFORMANCE AND MAINTENANCE

### 10.1 PERFORMANCE CHARACTERISTICS

#### 10.1.1 SURFACE INFILTRATION RATES AND CLOGGING

The amount of water which can pass through a concrete block permeable pavement is dependent on the infiltration rates of joint filling, laying course and permeable sub-base materials, not the proportion of open area in relation to concrete surface. Geotextiles in the upper layers can also affect the infiltration rate. The percolation through joints will vary with the materials used but a typical value for newly laid block paving is 4,000mm/hour. The permeable sub-base aggregates will have a percolation rate many times this, at least 40,000 mm/hour.

Regardless of the high percolation rate of the aggregates used in the openings and base, a key consideration is the lifetime design infiltration of the entire pavement cross-section including the subgrade. There can be short-term variations resulting from water already contained and long-term reductions of infiltration. A conservative approach should always be taken when establishing the design infiltration rate of a pavement system.

The infiltration rate will decrease but stabilise with age, due to the build-up of detritus in the jointing aggregate. This effect is summarised in Figure 37 and it can be seen that long service lives can be expected from permeable pavements, which is borne out by experience of older pavements. To ensure a long service life, it is essential that care is taken to protect the pavement during construction and from landscape runoff.

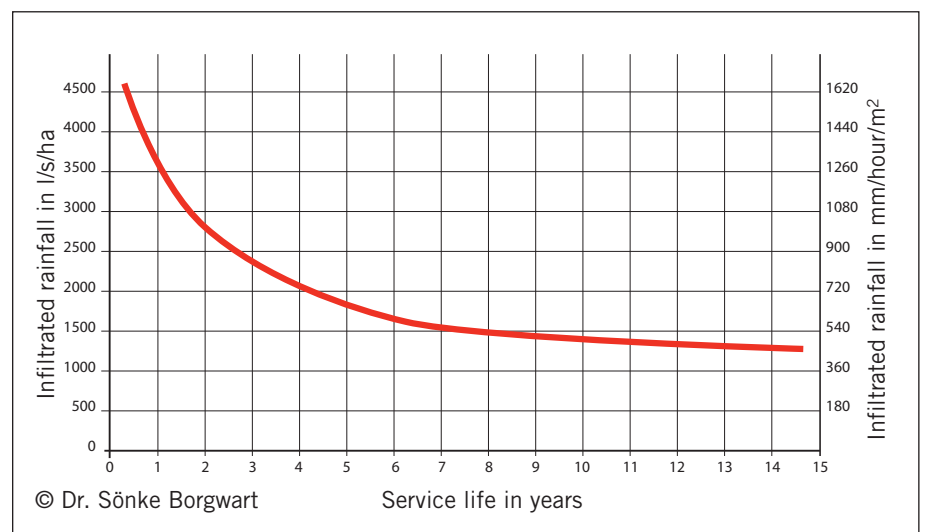

**Figure 37:** Typical reduction of surface infiltration rate over time.

American and German experience recommends that the design infiltration rate through the surface should be 10% of the initial rate, to take into account the effect of clogging over a 20-year design life without maintenance.

Even after allowing for clogging, studies have shown that the long-term infiltration capability of permeable pavements will normally substantially exceed UK hydrological requirements. Therefore permeable pavements can be designed to handle both prolonged rainfall and short duration storms. CIRIA Report C 582 gives further information on measured infiltration rates.

### 10.1.2 FREEZING

It is tempting to believe that frost heave may be a problem, bearing in mind the intentional presence of water within the pavement structure. However, this is not the case as water drains through the pavement before there is time for it to freeze. Permeable pavements have been used successfully in particularly cold climates. In the unlikely event that freezing did occur, it generally does not develop in a uniform manner and this allows the water displaced by the expanding ice to move within the open graded permeable sub-base, thus limiting the heave effects on the pavement.

Frost heave does not occur if the pavement is designed correctly. If the pavement is full and prolonged freezing does occur (a virtually impossible combination as the pavements are designed to drain down quickly after a rainfall event) then ice mushrooms may appear at the surface in the joints between the blocks as the water expands in the pore spaces between the aggregate. The only record of this happening is in the Midwest of the USA where the winter climate is far more severe than the UK. It should not be an issue in a correctly designed pavement.

It is of note that one of the most comprehensive studies into the performance of permeable pavements undertaken in the USA by Ferguson (2005) failed to find an example of a permeable pavement in a cold climate that had failed due to frost damage. This included one example of a 550mm deep pavement in an area with frost penetration up to 1800mm that had not experienced any objectionable distortion over 10 years. It was also found that frost penetration was shallower below permeable pavements than conventional dense construction because of the insulating effect of the pavement.

### 10.1.3 HEALTH & SAFETY AND ACCESSIBILITY

There is sometimes a perception that standing water in a permeable pavement can cause a potential health and safety issue, either due to stagnation of the water or freezing. This is not the case, as the systems are designed to drain quickly after a rainfall event and thus there should not be water standing for any significant period of time. In fact, concrete block permeable pavements provide a firm, level, well-drained surface that meet current accessibility requirements. Recent research in Ireland also shows that permeable pavements without slopes improve safety when using shopping trolleys in retail car parks, where discharged trolleys could run away into vehicles or pedestrians.

There is less risk of sheet ice forming on permeable pavements compared to normal pavements because puddles do not form on the surface. However hoar frosts may occur more frequently (CIRIA, 2001). Thus more frequent de-icing is required but with a lower rate of application to maintain a safe surface for traffic or pedestrians.

## 10.2 MAINTENANCE

As discussed previously, the infiltration rate of a permeable concrete block pavement will decrease but stabilise with age, due to the build-up of detritus in the jointing material. However, evidence to date suggests that infiltration rates always remain significantly higher than rainfall intensity, so, even without maintenance, there should be sufficient infiltration to accommodate rainfall events. Some manufacturers do recommend sweeping twice a year as a precaution against clogging, but this is no greater than is normally undertaken on traditional pavements. However experience suggests that this is rarely carried out on many sites and the permeable pavement is still working.

If the pavement does clog completely it may be possible to rehabilitate it using a road sweeper. Trials in the UK and France have shown that use of a jet wash and suction sweeper is more effective than a brush and suction sweeper at cleaning silt from the joints between blocks.

Most importantly, soil and other fine materials must be prevented from contaminating the pavement surface in the first place, for example with appropriate detailing as shown in Figure 33. Water ponding on the surface will almost certainly indicate that there is insufficient infiltration and the joints/voids may require sweeping clean or, in extreme cases, replacing.

As with conventional concrete block pavements, depressions, rutting and cracked or broken blocks, considered to be detrimental to the structural performance of the pavement or a hazard to users, will require appropriate corrective action.

### 10.3 ADOPTION

At the time of publication (January 2010) there is no specific provision for the adoption of SUDS techniques such as permeable pavements, although the situation will change as a result of new legislation. Existing legislation, such as Section 38 of the Highways Act, 1980 and Section 106 of the Town and Country Planning Act, 1990, can provide a mechanism for their adoption in some cases. Whatever route is taken it is recommended that early consultation be undertaken with the relevant stakeholders to ensure responsibilities for long term maintenance are agreed.

The Flood and Water Management Act 2010 applies to any construction work that creates a building or other structure, including 'anything that covers land (such as a patio or other surface)', that will affect the ability of land to absorb rainwater. When the Act has taken effect, applicable construction works cannot start until drainage systems have been approved by 'Approving Bodies' – generally county councils or unitary authorities – in line with national standards for SUDS. The existing right to connect surface water drainage systems to public sewers (under Section 106 of the 1991 Water Industry Act) will be restricted to those approved under the new regime, i.e. appropriate SUDS.

Approving Bodies will be obliged to adopt all approved drainage systems except those on single properties and public highways. Road drainage will be adopted by Highways Authorities with design, construction and maintenance in line with the new national standards. It is expected that the national standards, which must be met to gain approval, will be published by the government in 2011. They will cover the design, construction, maintenance and operation of SUDS. In the case of CBPP, the guidance in this Interpave document should provide the substantial basis for the relevant National Standard.

## 11. REFERENCES AND OTHER SOURCES OF INFORMATION

### 11.1 REFERENCES

- British Standards Institution (1996). *Method for determination of the relative hydraulic conductivity of permeable surfacings*. Draft for development. DD229:1996.
- British Standards Institution (2003). BS EN 13242: 2003, *Aggregates for unbound and hydraulically bound materials for use in civil engineering work and road construction*.
- British Standards Institution (2003). BS EN 1338: 2003, *Concrete Paving Blocks – Requirements and test methods*.
- Building Research Establishment (1991). *BRE Digest 365, Soakaway Design*. 1991.
- Cedergren H R (1974). *Drainage of highway and airfield pavements*. John Wiley and Sons.
- CIRIA (2001). *Source control using constructed pervious surfaces*. Report C 582, 2002.
- CIRIA (2001a). *Rainwater and greywater reuse in buildings: best practice guidance*. CIRIA Report C 539.
- CIRIA (2004). *Sustainable Drainage Systems. Hydraulic, structural and water quality advice*. Report C 609, 2004.
- CIRIA (2006). *Designing for exceedance in urban drainage – good practice*. CIRIA Report C 635.
- CIRIA (2007). *The SUDS Manual*. CIRIA Report C 697.
- Scottish Building Standards Agency (2007). *Scottish Building Standards: 2007. Technical Handbook 3, Environment*.
- Communities and Local Government (2006). *Development and flood risk. Planning Policy Statement PPS 25*. December 2006.
- Environment Agency (2001). *Guidance on requirements for prior investigation and monitoring (including requisite surveillance of groundwater) for activities authorised under the groundwater regulations 1998*. R&D Technical Report P2-174.
- Environment Agency (2006). *Use and design of oil separators in surface water drainage systems: Pollution prevention guideline PPG 3*.
- Evans E, Ashley R, Hall J, Penning-Rowsell E, Sayers P, Thorne C and Watkinson A (2004) *Foresight. Future Flooding. Scientific Summary: Volume II Managing future risks*. Office of Science and Technology, London.

- Ferguson B (2005). *Porous pavements. Integrative studies in water management and land development*. CRC Press, Florida.
- Highways Agency (2004). *Specification for Highway Works*.
- H R Wallingford (2000). *The Wallingford Procedure for Europe. Best Practice Guide to Urban Drainage Modelling*. Version 1.1, December 2000.
- Interpave (2005). *Concrete block paving. Guide to the properties design, construction, reinstatement and maintenance of concrete block pavements*, (available on [www.paving.org.uk](http://www.paving.org.uk)).
- Interpave (2006). *The cost of paving. Comparative initial construction and whole life cost analyses for pavements*. Prepared by Scott Wilson for Interpave (available on [www.paving.org.uk](http://www.paving.org.uk)).
- Kellagher RBB and Lauchlin CS (2003). *Use of SUDS in high density developments, defining hydraulic performance criteria*. H R Wallingford Report SR 640, December 2003.
- Kelly A. Collins, EI; William F. Hunt, PhD., PE; and Jon M. Hathaway, EI (2006) *Evaluation of various types of permeable pavements with respect to water quality improvement and flood control*. 8th International Conference on Concrete Block Paving, November 6-8, 2006 San Francisco, California USA.
- The National SUDS Working Group (2004). *Interim Code of Practice for Sustainable Drainage Systems*. July 2004.
- Office of the Deputy Prime Minister (2002). *The Building Regulations: 2000. Drainage and Waste Disposal*. Approved Document H, 2002 Edition.
- Rankin K and Ball J E (2004) *A Review of the Performance of Permeable Pavers*. International Conference on Water Sensitive Urban Design 2004. 21st-25th November 2004, Adelaide, South Australia.
- Scottish Executive (2001). *Planning Advice Note PAN 61, Planning and Sustainable Urban Drainage Systems*. July 2001.
- Scottish Executive (2004). *Scottish Planning Policy SPP7, Planning and Flooding*.
- BS4987-1:2005 'Coated macadam (asphalt concrete) for roads and other paved areas – Part 1: Specification for constituent materials and for mixtures.'



British Standards Institution (2009). BS 7533-13:2009, *Pavements constructed with clay, natural stone or concrete pavers. Guide for the design of permeable pavements constructed with concrete paving blocks and flags, natural stone slabs and setts and clay pavers.*

Department for Environment, Food and Rural Affairs (2009). *Draft Flood and Water Management Bill.*

British Standards Institution. BS 7533-1: 2001, *Pavements constructed with clay, natural stone or concrete pavers: Guide for the structural design of heavy duty pavements constructed of clay pavers or precast concrete paving blocks.*

British Standards Institution. BS 7533-2: 2001, *Pavements constructed with clay, natural stone or concrete pavers: Guide for the structural design of lightly trafficked pavements constructed of clay pavers or precast concrete paving blocks.*

British Standards Institution. BS 7533-3: 2005, *Pavements constructed with clay, natural stone or concrete pavers: Code of Practice for laying precast concrete paving blocks and clay pavers for flexible pavements.*

Interlocking Concrete Pavement Institute, USA. *Permeable Interlocking Concrete Pavements.* 1999.

Professor Brian Shackel of the University of New South Wales, Sydney, Australia. *Water penetration and structural evaluations of Permeable Eco-Paving.*

CIRIA. Project Report 22, *Infiltration Drainage – Case Studies of UK Practice.* 1995.

C B Elvidge and G P Raymond. *Laboratory survivability of non woven geotextiles on open graded crushed aggregate.* Geosynthetics International, Vol 6 No 2. 1999.

Institute of Hydrology. *The Flood Estimation Handbook.* 1999.

Environment Agency. *Policy and practice for the protection of groundwater.* The Stationery Office. 1998.

Carsten Dierkes, Lothar Kuhlmann, Jaya Kandasamy and George Angelis. *Pollution Retention Capability and Maintenance of Permeable Pavements.*

Claudia Yun Kang: 2006. *Performance Reviews of Hong Kong International Airport and Yantian International Container Terminals*.

## 11.2 OTHER SOURCES OF INFORMATION

CIRIA Website at [www.ciria.org/suds](http://www.ciria.org/suds)

ICPI document – *Permeable Interlocking Concrete Pavements* by David R Smith at [www.icpi.org](http://www.icpi.org)  
SEPA website at [www.sepa.org.uk](http://www.sepa.org.uk)

A number of SUDS development sites are shown at [www.suds-sites.net](http://www.suds-sites.net)

*Sustainable Drainage News* – published by CIRIA bi-annually on [www.ciria.org.uk/suds](http://www.ciria.org.uk/suds)

Environment Agency SUDS website at [www.environment-agency.gov.uk](http://www.environment-agency.gov.uk) (click on ‘Business and Industry’ and scroll down to SUDS).

Further information on drainage software packages can be obtained from Micro Drainage and Wallingford Software.

**This Guide and other useful information is available on the Interpave website: [www.paving.org.uk](http://www.paving.org.uk)**

## APPENDIX 1

### DESIGN EXAMPLES

The following design example considers two alternative design scenarios. The first part assumes that the ground conditions below the site are suitable for infiltration and System A can be used. The second part uses the same site layout but assumes that the ground conditions are not suitable for infiltration and that System C is used.

Finally we deal with the structural design.

### SITE ASSESSMENT

The project is located in Derby.  
 Hydraulic region  $M_5-60 = 20\text{mm}$ ,  $r = 0.4$  (Figure 20).

The car park has a height restriction barrier so that large vehicles are prevented from entering. Therefore use Class 2 loading – car parking (Table 7).

CBR (saturated) = 5% (sand and gravel)  
 Infiltration rate =  $4.3 \times 10^{-5}$  m/s

From Table 1 – the infiltration rate is between  $10^{-3}$  and  $10^{-6}$  m/s therefore it is suitable for System A. In addition the site is not contaminated and it is not within a groundwater source protection zone, it is not close to buildings and the runoff will not be excessively polluted (See Section 5).

There are limited underground services and the soils are suitable for infiltration, therefore unplanned excavations are unlikely and

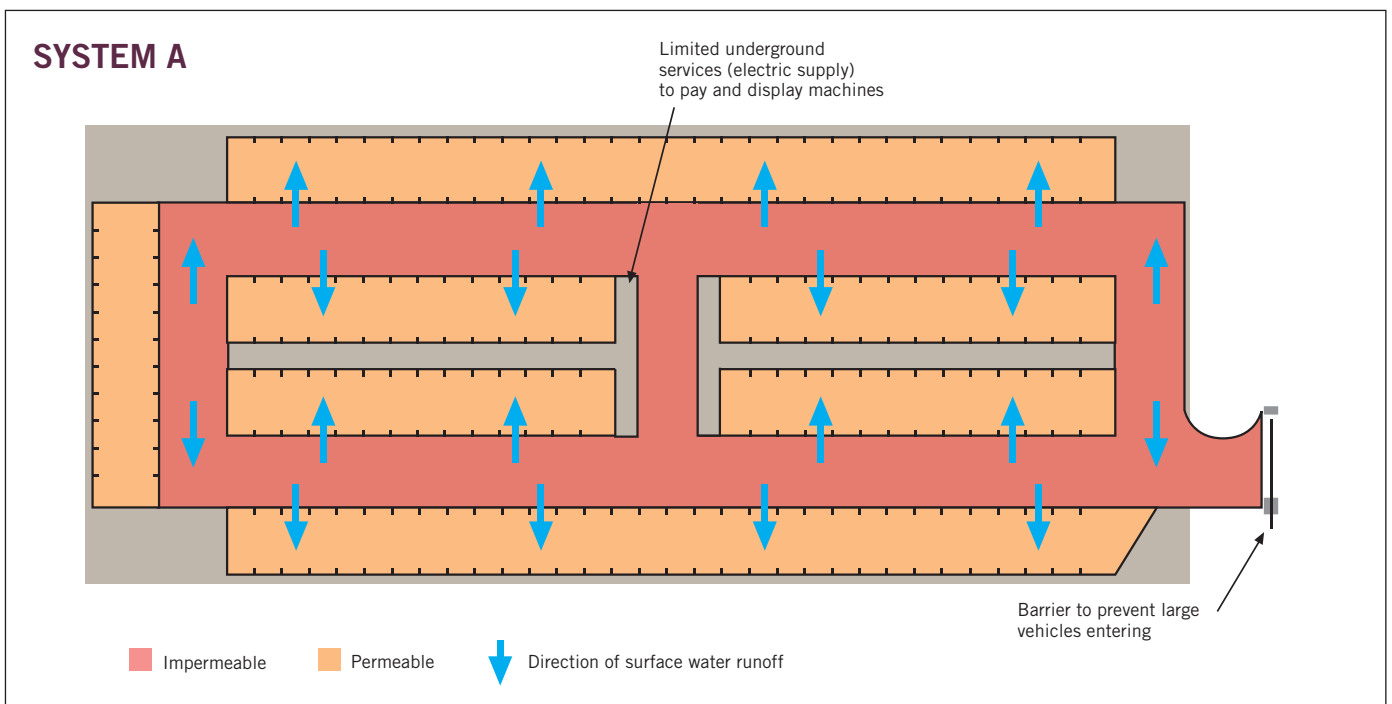

even if they do occur because the water simply passes through the pavement into the soil, the effect of any trench excavation will be minimal as water will simply flow to either side of the disturbance where the pavement will deal with it.

Total Area = 4217m<sup>2</sup>

Impermeable area = 2461m<sup>2</sup>

Permeable area (parking bays) = 1756m<sup>2</sup>

## WATER STORAGE DESIGN

Ratio of impermeable to permeable = 2461:1756 = 1.4:1 which is less than 2:1 so is acceptable. Use of Table 6 is acceptable (although conservative).

Infiltration rate =  $4.3 \times 10^{-5}$  m/s which is greater than  $1 \times 10^{-6}$  m/s so use of Table 6 is acceptable (although conservative).

Design the storage for a 1 in 30 year event to be stored within the permeable sub-base of the permeable pavement.

From Table 6 permeable sub-base thickness required = 230mm.

In this case because the water will infiltrate to the soils below there is no need to consider long term storage.

## ATTENUATION SYSTEM C

The next example uses the same site layout as previously but it is now assumed that the ground conditions are unsuitable for System A infiltration and that System C (attenuation) will be used where the water is stored in the sub-base which is connected to an outfall to drain the water away. This may be because the soils are not sufficiently permeable (soil infiltration rate is less than  $10^{-7}$ m/s or because the site is within a source protection zone or the site is underlain by contaminated soils.

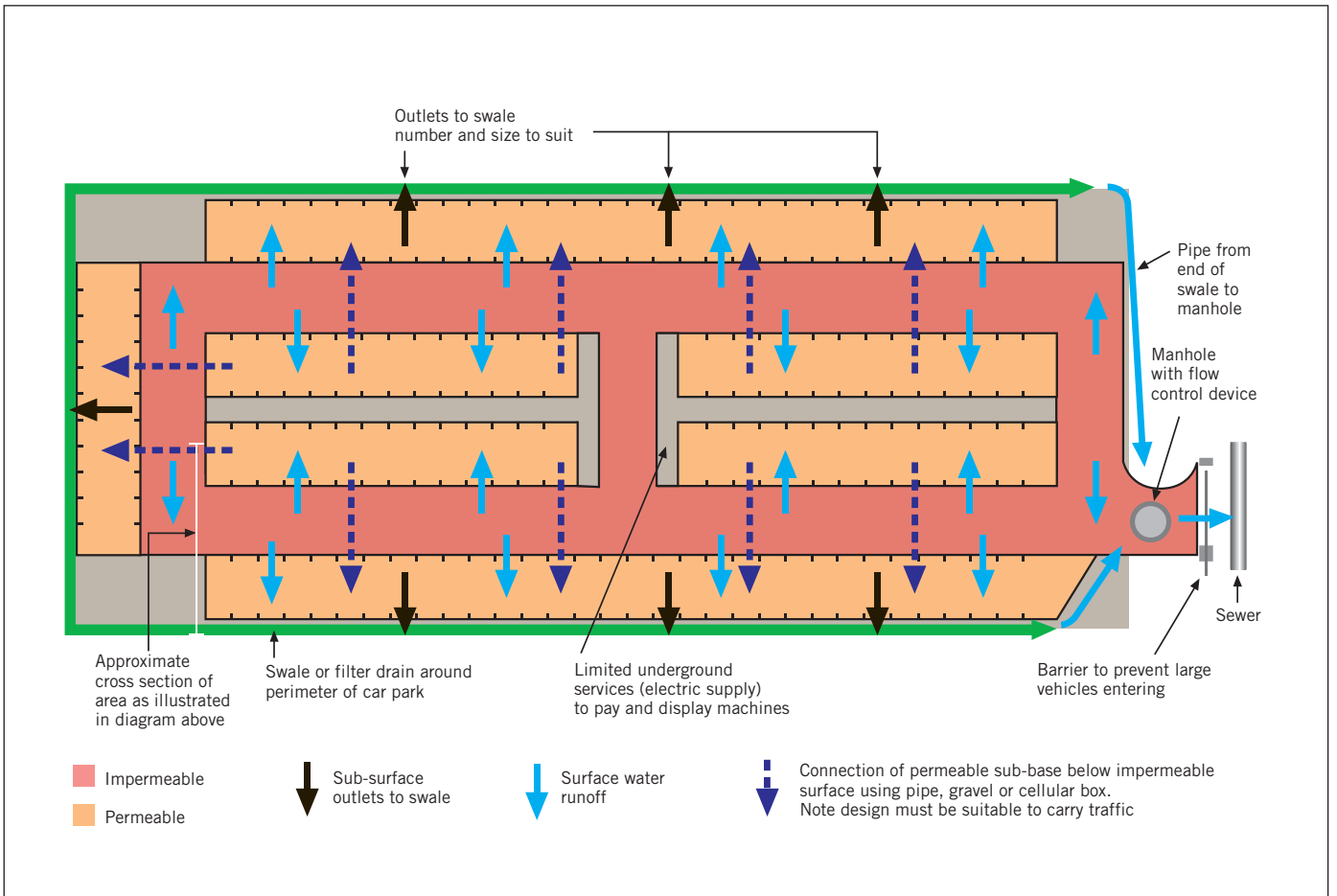
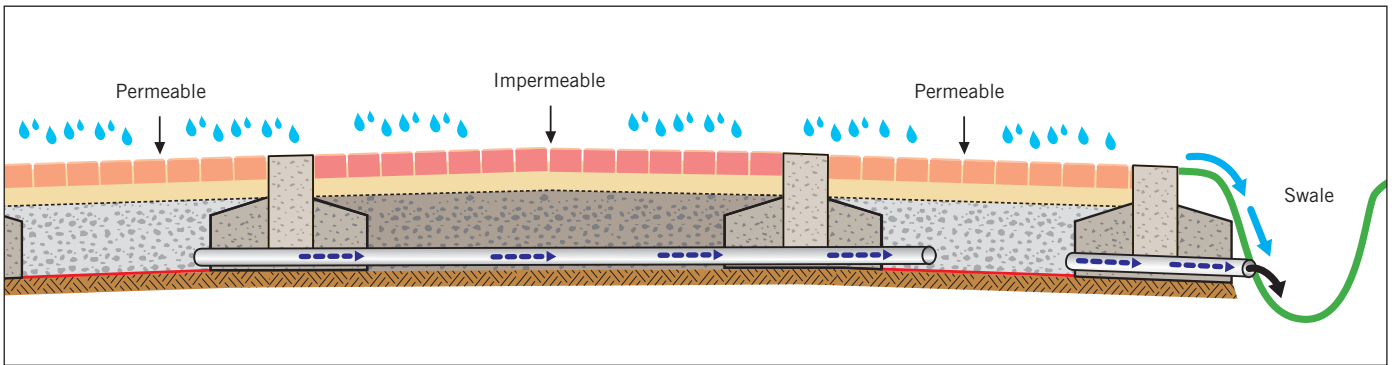

Total area = 4217m<sup>2</sup> so limiting discharge from site = 4217 x 7/10000 = 2.95l/s. In this case the water collected by the permeable pavement needs to be transferred into a conveyance system to take it to the outfall which is the sewer in the road to the top right of the plan. This can be achieved in a number of ways, but the conveyance system must be sized to provide sufficient capacity. Flow controls may also be required to ensure the water is stored in the relevant locations.

One possible layout is shown on the diagram, but there are other equally acceptable solutions.

From Table 5 the permeable sub-base depth required for attenuation is 120mm. This does not allow for any impermeable contribution.

So increase thickness based on:

$$\frac{\text{total of impermeable and permeable areas}}{\text{area of permeable paving}}$$

$$= \frac{120 \times 4217}{1756} = 288\text{mm}$$

Therefore, when rounded up, 290mm of permeable sub-base is required.

## CONVEYANCE SIZING

In a System C attenuation design the water will need to flow horizontally towards an outfall. In many designs the permeable sub-base will be present as discrete areas below the permeable paving, separated by impermeable construction. Careful consideration is required of water flows between different areas of permeable sub-base to ensure that it is held in storage in the correct area and that there is sufficient capacity in pipes or the sub-base to convey the water to the outlet(s).

Water can be moved between areas using pipes, geocellular boxes or a layer of coarse graded aggregate. Water can also flow along areas of permeable sub-base. On sites that are level it is usually possible to use a limited number of flow controls to ensure that the use of storage in the each area of sub-base is optimised. In this case the main consideration is ensuring that all conduits for water flow (pipes, sub-base, etc) have sufficient flow capacity to drain the area. On sloping sites a greater number of flow controls are usually required to hold water in the appropriate storage area.

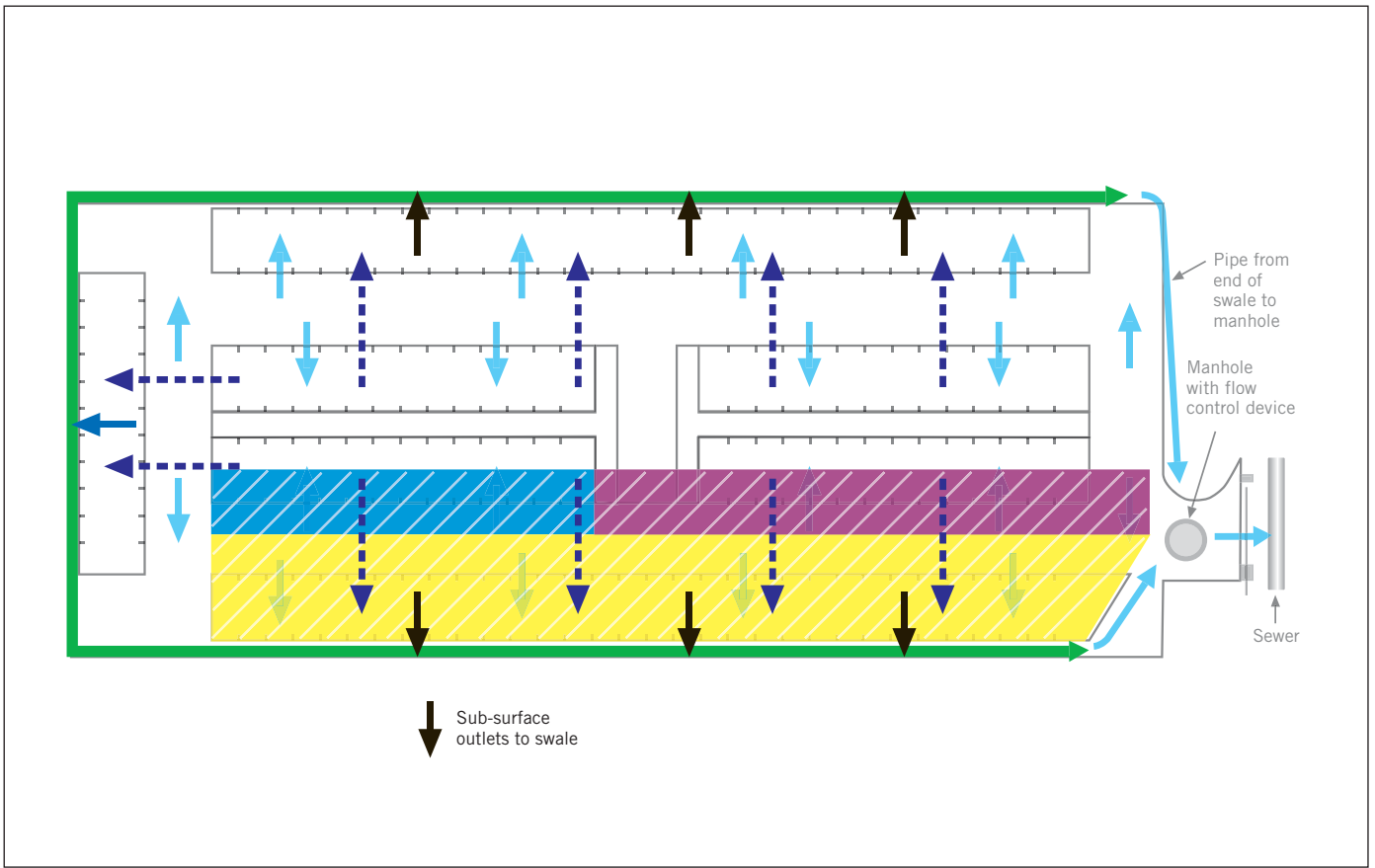

The coarse graded sub-base below the permeable pavement can also be used to convey water to the outfall, providing it has sufficient capacity. Alternatively water can be conveyed via a swale or filter drain around the edge of the site. In this case outlets will be required from the sub-base to the swale or filter drain at regular intervals. The number and size of pipes depends on the rate of flow that needs to be conveyed.

The allowable discharge rates for each area are calculated using the following formula:

$$D_a = \frac{D_s \times A}{10,000}$$

Where:

- $D_a$  = allowable discharge rate for a particular area of storage (l/s)
- $D_s$  = allowable discharge rate for site, per hectare (l/s/ha)
- $A$  = sub-catchment area for sub-base storage being considered (m<sup>2</sup>)



The blue area will drain to the yellow area.

Blue area = 360m<sup>2</sup> therefore the pro rata restricted discharge rate is 7 l/s/ha x 360/10000 = 0.25l/s.

Therefore the conveyance from the blue area under the impermeable area must be either at this rate or greater, depending on whether flow control is required at this point to ensure the storage operates when required.

In this case the site levels are relatively flat and the flow control for the whole site can be achieved at the main outlet to the sewer and the individual storage areas will operate as water backs up the system during a storm. So a gravel underlayer with a flow capacity of at least 0.25 l/s is required to carry the water from the blue area to the yellow area. A 100mm diameter pipe will achieve this at a nominal gradient of 1 in 1000 (1.84 l/s). If flow control was necessary at this point a very small orifice would be required (less than 20mm) so at this point it is best to rely on water backing up the system from a flow control further downstream.

The yellow area collects water from yellow, blue and purple areas. Total area (yellow + blue + purple) is 1560m<sup>2</sup> so the pro rata restricted discharge rate is 7 l/s/ha x 1560/10000 = 1.1 l/s.

So, again only one 100mm pipe is required to remove the water from the permeable sub-base into the swale or filter drain. (1.84 l/s).

However, in practice two or three may be provided to ensure more efficient drainage of the permeable sub-base.

#### CALCULATION OF PERMEABLE SUB-BASE FLOW CAPACITY BELOW THE IMPERMEABLE AREA

Open graded aggregate can be used to convey the water below the road.

Assume 100mm thickness of 4/20 permeable sub-base material.

Note: this calculation is dependent on the permeability of the permeable sub-base and the following is a method of obtaining a rough estimate of the flow capacity of permeable sub-base. If the capacity is critical the permeability of the permeable sub-base should be measured in laboratory tests and a more detailed analysis of flow should be completed.

#### CALCULATE FLOW THROUGH THE PERMEABLE SUB-BASE USING DARCY'S LAW

$$Q = Aki$$

Assume hydraulic gradient is nominal 1 in 500 (slope of subgrade to outlets). Therefore hydraulic gradient  $i = 0.002$

$$k = 0.01 (D_{10})^2 \text{ Hazen's Formula}$$

For the Interpave specification permeable sub-base the maximum allowable  $D_{10}$  is approximately 10mm although in practice the maximum that can be achieved and also meet the other requirements is about 7 or 8 mm.

Assume  $D_{10}$  of permeable sub-base = 7mm

$k = 0.5 \text{ m/s}$

The permeable sub-base to drain below the impermeable area is 100mm thick. Assume it is provided below the complete impermeable area so, width = 45m.

Cross sectional area of gravel through which flow occurs =  $0.1 \times 45 = 4.5\text{m}^2$

$Q = 4.5 \times 0.5 \times 0.002 = 0.0045\text{m}^3/\text{s} = 4.5\text{l/s} > \text{flow required from blue area to the yellow area (0.25 l/s)}$ .

#### CALCULATION OF PERMEABLE SUB-BASE FLOW CAPACITY ALONG THE YELLOW AREA

Note: this calculation is dependent on the permeability of the permeable sub-base and the following is a method of obtaining a rough estimate of the flow capacity of permeable sub-base. If the capacity is critical the permeability of the permeable sub-base should be measured in laboratory tests and a more detailed analysis of flow should be completed.

Calculate flow through the permeable sub-base using Darcy's Law. Flow is perpendicular to the width in this case.

$Q = Aki$

Assume hydraulic gradient is nominal 1 in 500 (slope of subgrade to outlets). Therefore hydraulic gradient  $i = 0.002$ .

$k = 0.01 (D_{10})^2$  Hazen's Formula.

For the Interpave specification permeable sub-base the maximum allowable  $D_{10}$  is approximately 10mm although in practice the maximum that can be achieved and meet the other requirements is about 7 or 8mm.

$D_{10}$  of permeable sub-base = 7mm.

$k = 0.5 \text{ m/s}$

Permeable sub-base is 290mm thick and the parking bay is 5m long.

Cross sectional area of gravel through which flow occurs =  $0.29 \times 5 = 1.45\text{m}^2$ .

$$Q = 1.45 \times 0.5 \times 0.002$$

$Q = 0.00145\text{m}^3/\text{s} = 1.45 \text{ l/s}$  (this is equivalent to a restricted discharge for the contributing areas of  $9.3 \text{ l/s/ha}$  so the sub-base above is not providing sufficient restriction and a flow control is required at the main outlet).

The flow is greater than  $1.1 \text{ l/s}$  that will be the minimum discharge for the areas drained. So therefore water flow along the sub-base is acceptable.

## STRUCTURAL DESIGN SYSTEMS A & C

Consider the design of a permeable pavement for the car park for which hydraulic design is undertaken. The parking bays will be trafficked only by light vehicles. Because Large Goods Vehicles are prevented from entering the car park, the permeable paving can be designed for Load Category 2. The pavement is to be designed as a System A (infiltration) hydraulic system. The subgrade has a soaked California Bearing Ratio of 5%. The development is large so it is assumed that there will be 5,000 standard 8,000kg axles during the construction phase.

### Stage 1

Use Table 7 to select the Category of Loading from 1 to 6. In this example, the parking bays are Load Category 2 (Car Parking) which will take 100 cumulative standard axles.

### Stage 2

For System A use the Design Chart shown as Figure 23 to determine the structural design.

The design section for the Car Park (Load Category 2) is:

- 80mm thickness concrete block permeable paving**
- 50mm thickness laying course material**
- 350mm thickness permeable coarse graded aggregate**
- Geotextile between the subgrade and coarse graded aggregate**

For System C use the Design Chart shown in Figure 24 to determine the structural design.

The design section for the car park (load category 2) is:

**80mm thickness concrete block permeable paving**  
**50mm thickness laying course material**  
**350mm thickness permeable coarse graded aggregate**  
**150mm thickness of capping material**  
**Impermeable membrane Category 1 (2000 gauge polythene)**  
**between the capping layer and coarse graded aggregate**

### Stage 3

From Table 8 adjust the thicknesses from the Design Chart for pavements installed over subgrades of CBR less than 5%. In this case, no adjustment is required.

### Stage 4

Permeable pavement construction materials must be kept clean during the construction phase. For those parts of the car park which are to be used as a site access route, install a Dense Bitumen Macadam (DBM) course. Just prior to laying the concrete block permeable paver, punch 75mm diameter holes on an orthogonal 750mm grid. The cumulative number of standard axles during the construction phase is 5000 and the cumulative number of standard axles during the in-service phase is 100 so the total design figure is 5100. From Table 9, the thickness of the Dense Bitumen Macadam layer is 130mm. Therefore, the design section for those parts of the Car Park subjected to site traffic is:

### System A (infiltration)

**80mm thickness concrete block permeable paving**  
**50mm thickness laying course material**  
**130mm thickness Dense Bitumen Macadam with holes punched**  
**350mm thickness unbound coarse graded aggregate**  
**Geotextile between the subgrade and coarse graded aggregate**

and

### System C (no infiltration)

**80mm thickness concrete block permeable paving**  
**50mm thickness laying course material**  
**130mm thickness Dense Bitumen Macadam with holes punched**  
**350mm thickness unbound coarse graded aggregate**  
**Impermeable membrane Category 1 (2000 gauge polythene)**  
**150mm thickness capping**

**FINAL PAVEMENT THICKNESS**

The table below tabulates the pavement thicknesses for the structural and hydraulic design for Systems A and B.

To determine the final pavement thickness for System A or C, select the greater thickness.

	<b>System A</b>	<b>System B</b>
Hydraulic pavement design thickness	230mm	290mm
Structural pavement design thickness (no site construction access required)	350mm CGA	350mm CGA 150mm capping
Structural pavement design thickness (site construction access required)	130mm DBM 350mm CGA	130mm DBM 350mm CGA 150mm capping

Summary of pavement design thickness.

**Stage 5**

Prepare specification clauses for the materials within the permeable pavement.



**Marshalls**



**TOWNSCAPE**  
Products Limited



[www.paving.org.uk](http://www.paving.org.uk)

60 Charles Street, Leicester LE1 1FB United Kingdom  
e: [info@paving.org.uk](mailto:info@paving.org.uk) t: 0116 253 6161 f: 0116 251 4568

INTERPAVE IS A PRODUCT ASSOCIATION OF THE BRITISH PRECAST CONCRETE FEDERATION LTD

---



t: 0116 253 6161 f: 0116 251 4568  
e: [info@britishprecast.org](mailto:info@britishprecast.org) [www.britishprecast.org](http://www.britishprecast.org)



t: 0116 222 9840 f: 0116 251 4568 e: [info@interlay.org.uk](mailto:info@interlay.org.uk) [www.interlay.org.uk](http://www.interlay.org.uk)